

ROADSIDE ASSISTANCE/WARRANTY

Mazda Roadside Assistance
Exhilaration, liberation and inspiration, are great reasons to drive a Mazda car, truck or SUV. In addition to all the other great standard features, you also get peace of mind with our basic warranty period Emergency Roadside Assistance Plan, it's just a phone call away, 24 hours a day, 365 days a year, call **1-800-866-1998**.

Mazda "bumper-to-bumper" Limited Warranty

We design and build every Mazda to give you driving pleasure now and far down the road. We're so confident in our quality that we cover the entire vehicle against defects in materials and workmanship for 36 months/36,000 miles, whichever comes first, plus we provide a powertrain warranty for 60 months/60,000 miles, whichever comes first.

This Quick Tips® guide is provided by Mazda Motor of America, Inc. to make your Mazda ownership experience more convenient. For complete details and operating instructions, see your Owner's Manual.

If you have any questions about your vehicle, you are invited to contact your local dealer. Or if you need additional help, feel free to call our **Customer Assistance Center at 1-800-222-5500** Monday through Friday, 8 a.m.-4:45 p.m., Pacific 9 a.m.-5:45 p.m., Eastern/Central

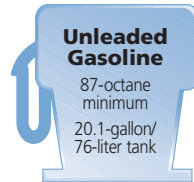

©2006 Calcar, Quick Tips® is a trademark of Calcar, made in USA 8/06 20.334M DOT ©2006 Mazda Motor of America, Inc. reserves the right to change product specifications at any time without incurring obligations. 9999-95-011C-07QT

2007

MAZDA CX-9



Quick Tips®

Reference
Guide for
Controls and
Functions

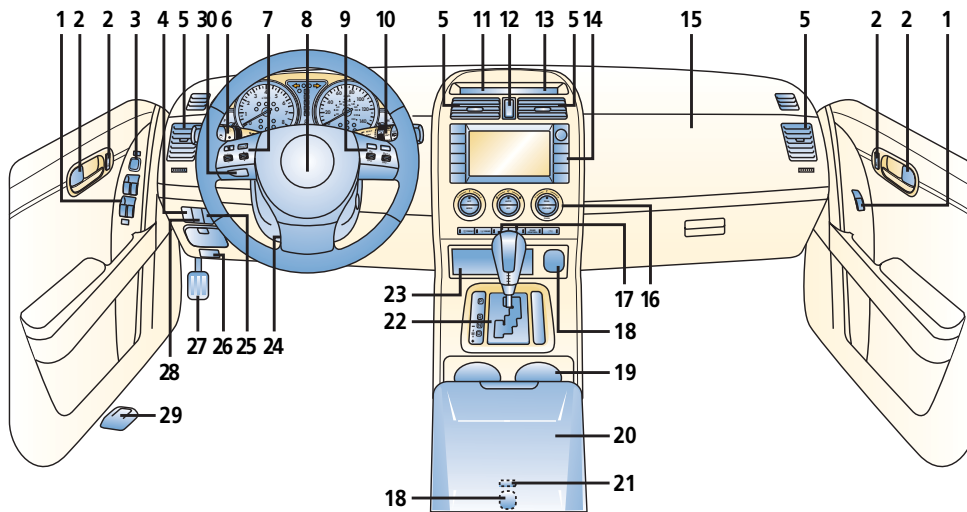

DRIVER'S VIEW



- | | | |
|---|--|--|
| <p>1. Power window switches,
see Mirrors/Windows</p> <p>2. Door locks,
see Locks</p> <p>3. Mirror controls,
see Mirrors/Windows</p> <p>4. Headlight leveling switch*,
see Getting Started</p> <p>5. Air vents</p> <p>6. Turn signal/lighting control lever,
see Getting Started</p> <p>7. Audio control switches,
see Getting Started</p> <p>8. Horn/Air bag
To beep: Press</p> <p>9. Cruise control,
see Getting Started</p> <p>10. Wiper/washer control lever,
see Getting Started</p> <p>11. Information display,
see Audio Systems</p> | <p>12.  Hazard warning switch
Push to activate/deactivate</p> <p>13. Passenger air bag off indicator,
see Getting Started</p> <p>14. NAVI display*,
see Owner's Manual</p> <p>15. Passenger air bag
see Audio Systems</p> <p>16. Climate control panel,
see Climate Controls</p> <p>17. Seat warmer*
Press: On/off</p> <p>18. Accessory socket</p> <p>19. Cup holders
To access cup holders:
Press cover down and lift</p> <p>20. Center console</p> <p>21. Auxiliary jack</p> <p>22. Gearshift lever,
see Transaxle</p> | <p>23. Storage</p> <p>24. Tilt/telescopic steering wheel release lever,
see Getting Started</p> <p>25. Power liftgate switch*
Press for more than one second or more to fully open/close liftgate</p> <p>26.  Hood release handle
Pull release handle to unlock</p> <p>27. Parking-brake
To engage: Push down
To release: Push down slightly, then release</p> <p>28. TCS OFF switch,
see Instrument Cluster</p> <p>29.  Fuel-filler lid release
To open: Pull lever upward and release</p> <p>30. HF/TEL Hands-Free Telephone button*,
see Getting Started</p> <p><small>*Denotes optional equipment</small></p> |
|---|--|--|

Always check the Owner's Manual for more operating information and safety features

Driver's
View

GETTING STARTED

Getting Started

MAZDA CX-9 Quick Tips® are designed to quickly familiarize you with some important features of your MAZDA CX-9

The Driver's View tab is your index to the Quick Tips®, locate the item you would like to learn more about and then turn to the listed tab

This Getting Started section contains important operating tips about your MAZDA CX-9. Items identified in blue text call out important information

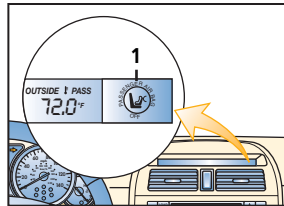
**Passenger air bag deactivation indicator light**

Front air bag deactivation indicator light (1) provides current status of front passenger air bag and pretensioner system

If total seated weight on front passenger seat is less than approximately 66 lb., front passenger air bag deactivation indicator light illuminates, front passenger and side air

bags/pretensioner will not deploy/activate in an accident. If the total seated weight is greater than approximately 93 lb., light does not illuminate, and the front passenger and side air bags/pretensioner will deploy/activate in an appropriate accident. See Owner's Manual for additional information on this feature and the air bag system.

⚠ WARNINGS: Even with a deactivation system, never place rear-facing infant-safety seat in front of any air bag, an infant is in serious danger of being injured or killed. If you must install a forward-facing child-safety seat in the front seating position, move vehicle seat as far back as possible.

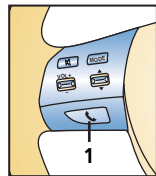

(HF/TEL) button (1) located on steering wheel, information display and microphone; system only functions with a Bluetooth type mobile telephone, a mobile telephone can be programmed only when vehicle is parked

Bluetooth Hands-Free Telephone (HF/TEL)***Before using**

System consists of Hands-Free Telephone

Hands-Free Telephone setup Pair a phone

Quickly press telephone button (1); say "setup" after beep, system prompts you with available options; say "pairing options" after beep, say "pair", system will ask for a 4-digit PIN of your choice (record PIN number for future phone pairing procedure), slowly say your 4-digit PIN, follow your cellular phone manufacturer's instructions for placing phone in pairing mode, select Bluetooth on phone, then enter your selected 4-digit PIN on phone's numeric keypad, system prompts you to name the phone, system will ask for a phone priority number between 1-7, 1 being highest, when programming is complete, system will indicate "pairing complete"

Language

Quickly press telephone button (1); say "setup" after beep, say "language" after beep, say "selected language", you will be asked "is this correct", say "yes" after the beep, then follow any additional prompts

Dialing a phone number

Quickly press telephone button (1); say "dial" after beep, slowly say phone number after the prompt, system verifies number is correct, system says "dialing" and then connects your call

Redialing last-called number

Quickly press telephone button (1); say "redial" after beep, system will redial last dialed phone number

See Owner's Manual for complete operating instructions and warnings

*Denotes optional equipment

Always check the Owner's Manual for more operating information and safety features

GETTING STARTED

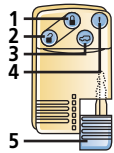

Advanced keyless entry/start system*

Advanced key must be carried by driver to operate properly

Refer to Owner's Manual for additional instructions

Tip: Do not use advanced key with activated cell phone in the same pocket, advanced key functions may become disabled

Advanced keyless system customization

Your authorized Mazda Dealer can customize your system if desired with features such as auto-lock: After exiting the vehicle after driving, the car will automatically lock

For additional information on customizable features, see Owner's Manual

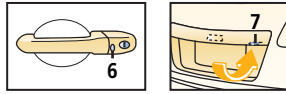

Locking doors

Driver's/passenger's door request switch: Press (6) once on either door to lock other doors
Press and hold driver's door request switch (6) to close windows and moonroof, release to stop

Advanced key transmitter: Press (1) button; pressing again within a few seconds causes doors to relock and horn to beep

Unlocking doors/opening liftgate

Driver's door request switch: Press (6) to unlock driver's door; press again within 3 seconds to unlock other doors and liftgate

Passenger's door request switch: Press (6) on passenger's door; all doors and liftgate unlock simultaneously

Liftgate request switch: Press (7) on liftgate, doors and liftgate will lock/unlock

Advanced key transmitter: Press (2) button for driver's door; press again within 1 1/2 seconds to unlock other doors and liftgate, hold to lower front windows and open moonroof, release to stop; with all doors unlocked, press and hold (3) button for one second or more to open/close liftgate

Activating panic alarm

Panic alarm: Press and hold (4) button for more than 1 second; horn sounds, hazard warning lights flash; to stop, press any remote button

*Denotes optional equipment

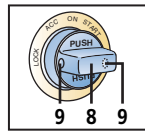

Starting engine

Press start knob (8); when KEY indicator (green) illuminates on instrument

cluster; turn start knob (8) to START position to start engine

Tip: Engine will not start if liftgate is open and advanced key is placed in liftgate/cargo area

Auxiliary key operation

If advanced key cannot be used due to a malfunction or dead battery, use auxiliary key (5) to lock/unlock doors and to start vehicle

To start vehicle: Remove start knob cover (8) by pressing both side release buttons (9) while pulling; insert auxiliary key into key cylinder and turn to start engine

Tip: Do not place advanced key on or around dashboard, storage

compartments such as glove box or in open liftgate/cargo area, engine may not start or warnings may activate

Turning off engine

Turn start knob to ACC position to turn engine off, push in and turn start knob to LOCK position

Tip: Vehicle battery may be discharged if start knob is left in ACC position

Always put vehicle in Park (P), set parking brake and turn start knob to LOCK position when exiting vehicle

System operation warnings

KEY indicator light flashes (green) indicates advanced key transmitter battery power is low

KEY indicator light illuminated continuously (red) indicates system malfunction, and auxiliary key should be used, have vehicle inspected at an Authorized Mazda Dealer as soon as possible

Tip: When using advanced keyless system, system will beep as confirmation of lock/unlock requests, system will also beep if start knob is left in ACC position, advanced key has been left in vehicle or if advanced key is removed from vehicle while vehicle is running

For additional system operation warnings, see Owner's Manual

Replacing battery

See Owner's Manual for complete instructions

Cautions on use

To avoid damage to advanced key, do not allow any severe impacts or contact with liquids, do not place heavy objects on advanced key and do not leave advanced key exposed to direct sunlight or high temperatures, See Owner's Manual for all cautions and warnings

Always check the Owner's Manual for more operating information and safety features

GETTING STARTED

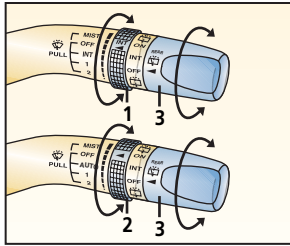

Wiper/washer lever

Single wipe: Push lever up
 Washer: Pull back, also operates wipers
 Intermittent wiper: One click down, to change interval speed rotate ring (1)
 Auto*: One click down, rain sensor senses rain amount on windshield, then controls wiper automatically
 Rain sensor sensitivity is adjusted from high sensitivity (+) to less sensitivity (-) by rotating ring (2)

Normal wiper speed: Two clicks down
 High-speed wiper: Three clicks down
Rear window wiper/washer
 To activate rear interval wiper: Rotate knob (3) up to INT
 To activate rear normal speed wiper: Rotate knob (3) up to ON
 To activate rear washer: Rotate knob (3) to and release

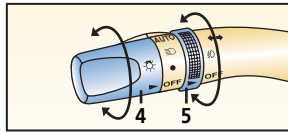

Turn signal/lighting lever

OFF = Lights off
 = Tail, parking and dashboard lights on: Rotate knob (4) to first notch
 = Tail, parking, dashboard and headlights on: Rotate knob (4) to second notch

High beams on/off: Push forward/pull back to detent
AUTO* = With ignition switch in ON position; headlights and exterior lights automatically turn ON/OFF depending on surrounding darkness/lightness; rotate knob (4) to third notch
 To flash high beams: Pull back slightly and release

Turn signals right/left: move lever up/down
 = Fog lights* on: Rotate (5); functions only with low beams on

Tips: Beep sounds when headlights are left on, ignition off, this is a normal condition. Headlights switch off automatically within 30 seconds (in a few seconds with AUTO* selected) if lights are left on and switch is in lock position or key removed

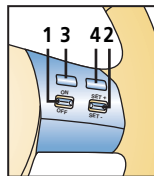

Cruise control

Operates above 19 mph
 Pull up/press down ON/OFF switch (1) to enable/disable

To set speed: Press switch (2) down and release
 To increase set speed: Press switch (2) up and release at desired speed
 To decrease set speed: Press switch (2) down and release at desired speed
 To cancel: Press down ON/Off switch (1), tap brake or press CANCEL switch (3)
 To resume cruising speed: Press switch (4); resume function will not operate if cruise control was cancelled using ON/OFF switch

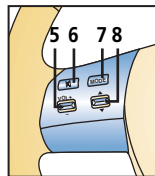

Steering-wheel audio controls

To increase/decrease volume: Pull up/press down (5)

Press (6) to either mute standard Audio system or activate Navigation Voice Command*
 Press (7) to select AM, FM 1, FM 2, CD, RSES* and AUX mode if external device is connected to auxiliary jack
 Radio: Pull up/press down / (8) less than one second to select next/previous preset station, pull up/press down / (8) for two seconds until beep sound is heard to seek next/previous station
 CD: Pull up/press down (8) to select next track, pull up/press down (8) to repeat current track

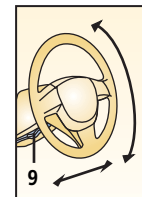

Tilt/telescopic steering-wheel lever

Pull lever (9) down to unlock column; adjust tilt angle/column length; pull up to lock column

WARNING: Do not adjust steering-wheel while driving because you may lose control of the vehicle



HID headlights leveling switch*

Set position at 0 unless vehicle is loaded heavily, leveling switch adjusts headlight angle to compensate for weight of passengers and cargo, see Owner's Manual

*Denotes optional equipment

Always check the Owner's Manual for more operating information and safety features

Instrument Cluster

INSTRUMENT CLUSTER

GAUGES

1. Instrument cluster dimmer select knob

With headlights ON: Rotate knob to increase/decrease brightness
Headlights/parking lights ON, ignition key ON: Illumination changes brightness when knob is pressed

2. Tachometer

3. Gear position indicator

Displays current gear position or manual mode

4. Gear indicator

Displays current gear when in D or M

5. Speedometer

6. Odometer/Trip meter selector

Press to view odometer, trip meter A and B; press and hold to reset trip meter A/B settings

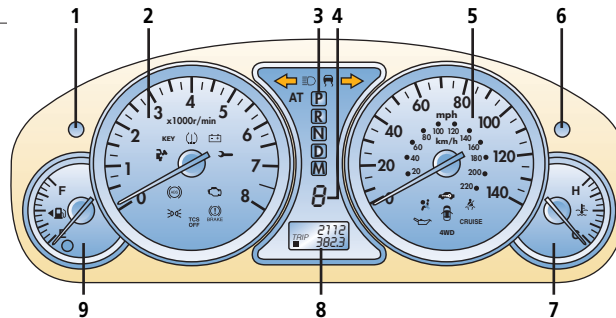

7. Engine coolant temperature gauge

Stop car if above normal range, turn off engine, let vehicle cool; check coolant level when safe

8. Odometer/Trip meter

20.1-gallon/76-liter tank

*Denotes optional equipment

WARNING LIGHTS

- **CRUISE Cruise control on**
Amber light: Cruise control system activated; Green light: Cruising speed set; see Getting Started
- **Tire Pressure Monitoring System (TPMS)***, see Driving Tips
- **High beams on**
- **Engine oil-pressure**
Stop car when safe and turn off engine; check oil level
- **Brake system**
Parking brake on/low brake fluid
- **Always fasten seat belts**
- **Security indicator light***
- **Low fuel**
- **Door ajar**
- **Check fuel cap**
Fuel cap not securely tightened
- **Check engine**
Dealer inspection required if light remains on, see Owner's Manual
- **Charging system**
Charging system malfunction; dealer inspection required
- **Air bag/front seat belt pretensioner system**
If light flashes or stays on, the air bags/front seat belt pretensioners may not operate in an accident; dealer inspection required
- **AT Automatic transaxle***
Automatic transaxle malfunction; dealer inspection required
- **Anti-lock Brake System (ABS)**
ABS malfunction, normal brakes only; dealer inspection required
- **KEY***, see Getting Started
- **TCS OFF**
Traction Control System is deactivated
- **Lights ON indicator light***
- **Traction Control System (TCS)/Dynamic Stability Control (DSC)/Roll Stability Control (RSC)**
Light flashes when system is activated while driving; dealer inspection required if light remains on
- **4WD AWD warning light***
Flashing lamp indicates high temperature differential oil, illuminated lamp indicates an abnormality with AWD system; dealer inspection required
- **Wrench light**
Dealer inspection required if light remains on, see Owner's Manual

Always check the Owner's Manual for more operating information and safety features

Instrument Cluster

Locks

LOCKS

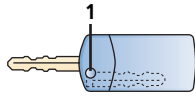

Key

Operates ignition and all locks

Tips: Use key number plate to purchase a new key; store in safe place separate from vehicle. Only advanced keyless system automatically locks doors when leaving with key (dealer programmable feature).

Retractable type key

To fold/unfold press button (1)

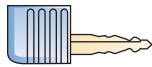

Auxiliary key*

See Getting Started

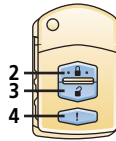

Keyless entry system

Functions only with ignition in OFF position

To lock doors: Press button (2);

pressing again within a few seconds causes doors to relock and horn to beep

To unlock: Press button (3) for driver's door; press again within 3 seconds to unlock other doors and liftgate, press and hold to lower driver's and passenger windows and open moonroof, release to stop

Panic alarm: Press and hold button (4) for more than 1 second; horn sounds, hazard warning lights flash; to stop, press any remote button



Advanced keyless entry/start system/auxiliary key*

See Getting Started

Illuminated entry system
Activates interior lights when dome light switch set to DOOR position; lights off after driver's door is locked or ignition in ON position

Immobilizer system

Prevents engine from running unless coded key is used, see Owner's Manual

WARNING: Never leave a child alone in vehicle and never leave any key where a child can find it, particularly advanced keys which give easier access to a curious child

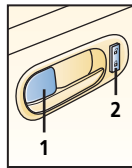

Manual door locks

To lock: Press front of button (1) toward door handle
To unlock: Pull front of button away from door handle

Power door locks

To lock/unlock all doors and liftgate: Press bottom/top of switch (2)

Using key to lock all doors: Rotate key to clockwise position, continue to hold key in lock position to roll front windows up and close moonroof, release to stop

Using key to unlock driver's front door: Rotate key to counterclockwise position for more than one second to unlock other doors and liftgate, continue to hold key in unlock position to roll front windows down and open moonroof

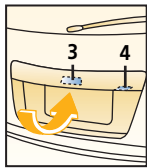

Liftgate

To open: Pull up on handle (3) and raise; to close: Push liftgate down with both hands until in near-shut position, easy closure system will close liftgate completely

Liftgate request switch

Liftgate request switch* (4) operation, see Getting Started

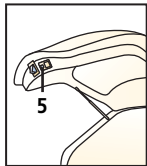

Power liftgate close switch

Press (5) for one second or more; hazard warning lights flash twice;

liftgate closes automatically after beep sound is heard

WARNING: Never place hands or fingers around liftgate because liftgate closes automatically from near-shut position, this could cause hands and fingers to be pinched and injured

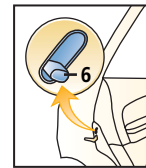

Child-safety locks

Located at edge of rear doors

To activate: Pull tab (6) up; door opens from outside only

To cancel: Push tab (6) down

WARNING: Since children may access either rear door, child-safety locks for both rear doors should be activated

*Denotes optional equipment

Always check the Owner's Manual for more operating information and safety features

Locks

Mirrors/
Windows

M I R R O R S / W I N D O W S

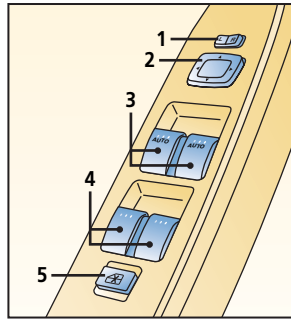

Dual power mirrors

Ignition switch must be in ACC or ON position
To adjust left/right mirror: Press selector (1) left/right, press (2) in direction of desired movement

Tip: To lock mirrors in place, move switch (1) to center position

Power window switches

With ignition ON
All windows controlled from driver's armrest; passenger doors have separate switches

Front window switches

One-touch down/up: Press/pull AUTO switch (3) firmly and release, window goes down/up all the way, press/pull briefly to stop, press/pull lightly and hold for normal operation, momentarily press front power window switches, front windows will open to vent position

Tip: During closing front window operation, front window will stop and open partway if object blocks window operation

Power window lockout switch

Press button (5), only driver's window operates; press again for normal operation

Rear window control switches

Push/pull (4) to open/close

Power window initialization procedure

If battery is disconnected or power window fuse is replaced, the auto open/close and anti-pinch features will not function until initialization is complete

Initialization procedure:

1. Turn ignition switch to "ON" position
2. Press front passenger power window switch down to fully open window, then pull switch up to close window completely, continue holding switch up for at least 3 seconds, then release switch
3. Move to driver's door and repeat Step 2 for driver's window
4. After windows have been initialized turn ignition to "LOCK", then back to "ON"

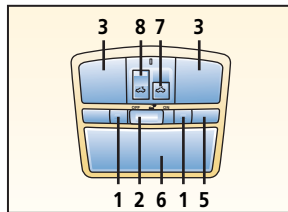

1. Map/reading light switch

Press on/off

2. Interior light switch

DOOR = light on when door open
ON = light always on
OFF = light always off

Tip: All interior lights can be turned ON/OFF using driver's overhead switch when all light switches are in DOOR position

3. Front interior light

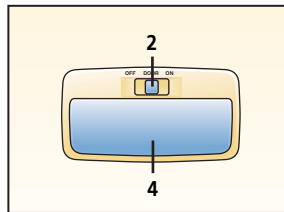

4. Rear interior light

5. Hands-Free Telephone/navigation microphone*

6. Storage/sunglasses holder

7. Moonroof tilt switch*

One-touch operation:
Tilt open/close, push/pull down switch

8. Moonroof slide switch*

One-touch operation:
Slide open/close, press rear/front of switch

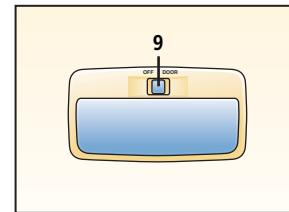

Tip: With all doors closed, moonroof and front windows can be opened via Keyless entry by pressing and holding unlock button, or opened/closed by turning and holding driver's door key toward front/rear of vehicle

9. Cargo light

DOOR = Light on with any door or liftgate open
OFF = Light always off

*Denotes optional equipment

Always check the Owner's Manual for more operating information and safety features

Interior
Lights

SEATS

Manual seat**1. Fore-aft adjustment**

Lift lever and hold, slide seat, release lever

2. Raise/lower seat (Driver's seat only)

Pull/push lever and release

3. Seat back angle

To adjust: Lift and hold lever, lean forward or backward to tilt seat, release lever

4. Manual lumbar adjustment (Driver's seat only)

Pull lever forward repeatedly for more support

5. Head restraint

To raise/lower: Pull up/hold release button (11) and push down

Power seat***6. Seatback angle**

Press front/rear of switch

7. Power lumbar adjustment*

Press front/rear of switch to increase/decrease lumbar support

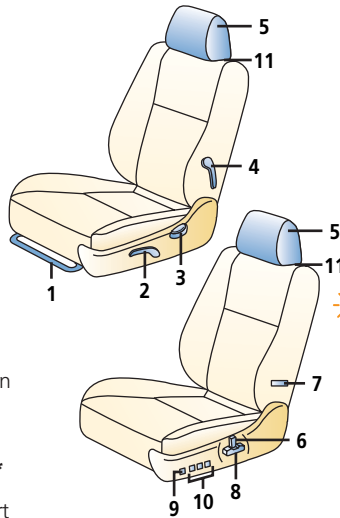
**8. Raise/lower front of seat**

Pull/push front of switch vertically

Fore/aft adjustment

Slide switch horizontally

Raise/lower rear of seat

Pull/push rear of switch vertically

Raise/lower seat

Pull/push center of switch vertically

Seat position memory*

Adjust seat, then press and hold set button (9), then select and press a memory position button (10) to save setting

Tip: To program memory seat into advanced key*/retractable key, with ignition off; key removed and driver's door open, press and hold set button (9) while holding unlock button on transmitter until beep is heard

⚠ WARNINGS: Do not adjust seats while driving

Safety belts must always be worn when vehicle is in motion

Air bags are supplemental and do not replace safety belt usage

Always wear your safety belt and properly secure children 12 and under in the rear seat

Even with a deactivation system, never place rear-facing infant-safety seat in front of any air bag, an infant is in serious danger of being injured or killed

If you must install a forward-facing child-safety seat in the front seating position, move vehicle seat as far back as possible

Shoulder belt height adjustment

To raise: Push adjuster up

To lower: Pull button (1), slide down; release button



⚠ WARNING: Make sure adjuster locks in one of its positions

Child-safety seat

To install in rear outboard seats: Use dual locking mode retractor seat belts; see Owner's Manual for proper installation and child seat tether and LATCH system instructions

⚠ WARNING: Use age appropriate child restraints, see Owner's Manual and state or province laws

Safety belt emergency locking mode

Belts lock only on hard acceleration, braking, cornering or impacts of about 5 mph or more

Automatic locking mode (front passenger and all rear safety belts only)

Must be used when installing child-safety seat

To activate: Pull webbing fully out of retractor, allow belt to retract until click is heard; belt will only tighten

To disengage: Unbuckle belt and allow webbing to retract fully

*Denotes optional equipment

Always check the Owner's Manual for more operating information and safety features

Rear Seats

REAR SEATS

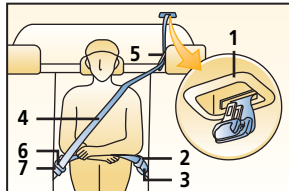

Rear center position seat belt[†]

To pull seat belt from ceiling recess (1): Slide tongues with finger while moving downward

Fastening seat belt: Tongue (2) and anchor (3) must be fastened, then slowly pull out lap/shoulder belt (4), put belt through loop (5)

and insert tongue (6) into buckle (7) until click is heard

Unfastening seat belt: Depress buckle button to release

Stowing seat belt: Retract belt, put tongues (2) and (6) together, insert securely into recess (1)

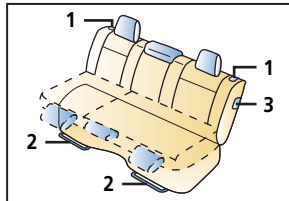

Folding second-row seats

Pull lever (1) up and lower seatback; when raising, lock into upright position

Seat slide

Moving seat forward/backward, raise bar (2) and slide seat to desired position; release bar

Seatback angle

Pull up lever (1), then lean back to desired position; release lever

Third-row seat access

Pull lever (3) and tilt seatback and slide seat forward

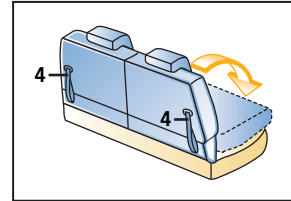

Folding third-row seats

Grip strap (4) and pull to fold seatback down

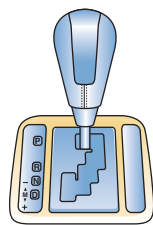

Automatic Transaxle

Gearshift must be in Park or Neutral to start engine; it must be in Park to remove ignition key

P = Park

To move gearshift from Park: Press firmly on brake pedal then move the shift lever out of P

R = Reverse

N = Neutral

No gear engaged

D Drive (Overdrive)

For normal driving: Shifts through all forward gears automatically



M (Sport A/T manual shift mode)

Move shifter from D to M to engage manual shift mode, M will be illuminated for manual mode on

shift position indicator located in the instrument panel

Manual shifting of transmission is achieved by moving shifter back to upshift and forward to downshift, move shifter from M to D to engage automatic shift mode



Gear indicator

Illuminated numeral of gear indicator located in the instrument panel displays current gear in Automatic and Manual shift modes

Tips: Back-up camera automatically operates when gearshift lever is placed into reverse and is viewable via navigation display screen**

When using back-up camera, objects may be closer than they appear, please check your surroundings

*Denotes optional equipment

**Back-up camera feature is only available with optional Technology Package

† See Owner's Manual

Always check the Owner's Manual for more operating information and safety features

Transaxle

Climate Controls

CLIMATE CONTROLS

1. Air flow selections

- = air to dash
- = air to dash and floor
- = air to floor
- = air to floor and windshield
- = air to windshield (defrost)

2. Temperature control driver/passenger

Cooler/warmer = rotate knob counterclockwise/clockwise

3. A/C = air conditioner

Press to turn on/off

4. OFF

Press to turn system OFF

5. Fan control

Rotate knob clockwise/ counterclockwise to increase/ decrease fan speed

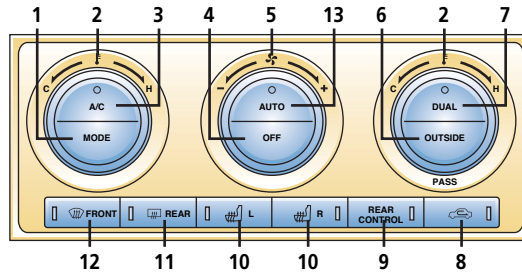

8. Air intake control

Press switch to alternate between recirculated (Indicator light on) or outside (Indicator light off) air mode

= recirculate inside air; use for maximum cooling

WARNING: Do not use position in cold weather, windows may fog and hamper vision

Automatic operation

Press AUTO (13) for automatic operation; rotate outer dial to set temperature, refer to information display for air flow selection, see Owner's Manual

Tip: Automatic climate control display viewed via information display, see Audio Systems

6. Outside

Press Outside button (6) to display outside temperature, press again to switch display to temperature set for air conditioner

Tip: To change from Fahrenheit to Centigrade or vice versa: Press and hold Outside button (6) for 3 seconds or more

7. Dual

Press (7) to switch between dual (driver/passenger) or individual temperature operation modes

9. Rear control

10. Seat warmer*

Press on/off

11. Rear window defogger

Press on/off; shuts off with ignition or automatically after 15 minutes of operation; also operates heated outside mirrors*

12. Windshield defroster switch

Press: Fresh air position is automatically selected, A/C automatically turns ON

Control positions for maximum defrost

Fan to maximum, temperature to maximum hot, selected

Tip: To help prevent windshield fogging in humid weather, select before starting engine

To prevent moisture buildup, never drive with system off

Objects placed under the front seats may interfere with air flow to the rear

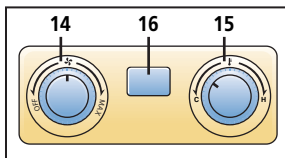

Rear climate control

Turn air conditioning (3) on; press rear control button (9), indicator light on, rear passengers can now control fan speed (14) and rear temperature (15)

Control On indicator (16) is illuminated when rear climate control is active

*Denotes optional equipment

Always check the Owner's Manual for more operating information and safety features

Climate Controls

Audio Systems

AM / FM STEREO / CD / CD CHANGER

1. Power/Volume

Press to turn on/off; rotate to increase/decrease volume

2. Random

Press to play CD selections in random order, press again to cancel

3. Auto-Memory

Press and hold until a beep sound is heard; system automatically scans and temporarily stores six strong stations in each band; press again to switch to another preset station

DISP

CD: Press repeatedly to scroll through displays

Text*: Rotate right/left to display titles longer than 12 characters

4. Tune

Radio: Rotate counter clockwise/clockwise for lower/higher frequency

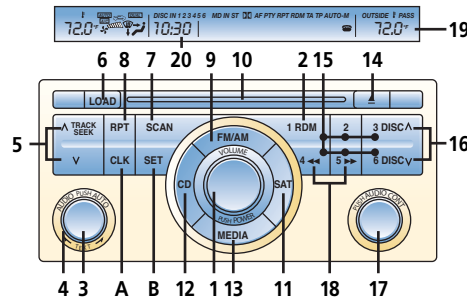

7. Scan

Radio: Press to sample strong stations, press again to stop at current station

CD: Press to play first few seconds of each selection, press again to stop at current selection

8. RPT

Press to replay current CD selection

18. Reverse ◀◀ / Fast forward ▶▶

Press to reverse/fast forward through a track

19. Information display

Has the following functions: Clock, audio display, automatic climate control display and outside temperature display

5. SEEK/TRACK

Radio: Press ▲ / ▼ to automatically seek higher/lower frequency

CD: Press ▲ / ▼ to select next track/beginning of current track

6. LOAD*

To load multiple discs: Press and hold LOAD (6) until beep sound is heard; insert CD when "IN" is indicated on information display (19)

To eject disc: Press Eject (14)

To eject specific disc: Press and hold Eject (14) until beep sound is heard; within five seconds press the desired tray number 1-6 (15)

9. FM/AM

Press to turn radio on and select between FM1/FM2/AM station preset buttons (15)

10. CD slot

11. SAT*, Satellite ready capability

12. CD, Press to play CD

13. Media (AUX)

Select external digital devices

14. CD eject button

15. Memory preset buttons

To set: Tune to station, press and hold until beep sound is heard

16. Disc ^ / v *

Press to skip to next/previous CD

17. Audio control

Audio: Press to select ALC/BASS/TREB/FADE/BAL/BEEP/Surround* OFF/1/2/3, rotate right/left to adjust selected feature

Tip: Automatic Level Control (ALC) automatically adjusts audio volume depending on vehicle speed

Clock**

To set: With ignition in ACC or ON position, press (A) and hold until beep sounds; 12hr/24hr will appear on display (20); press (B) to select; press (A) again while selection is flashing; Hr ADJUST displays; press (B) to select hour; press (A) when done, do the same to set minutes

Navigation/Audio system*

AudioPilot* (BOSE system) Automatically adjusts audio volume in accordance with level of noise entering vehicle; press on-screen button to turn ON/OFF

Centerpoint* (BOSE system) Delivers multi-channel surround sound while listening to CDs

See Owner's Manual for complete details

Rear entertainment system*

See Owner's Manual

*Denotes optional equipment
**See Navigation Owner's Manual for clock setting procedure if equipped with Navigation System

Always check the Owner's Manual for more operating information and safety features

Audio Systems

Cargo Area

CARGO AREA

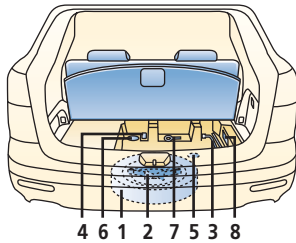

Spare tire

1. Temporary spare tire

Stored under vehicle; to change flat tire: Follow instructions in Owner's Manual

⚠ WARNING: Do not exceed 50 mph with temporary spare

💡 Tip: For instructions and restrictions on use of temporary spare tire, see Owner's Manual

2. Jack

3. Lug wrench and jack lever

4. Spare tire jack screw socket

5. Spare tire jack screw

6. Spare tire hold down strap

7. Tie-down eyelet

8. Navigation DVD player**

4 6 1 2 7 5 3 8

Cargo area

9. Cargo securing loops

10. Cargo floor

💡 Tip: Cargo floor cover can be secured in raised position by attaching third-row straps (14) to underside of floor cover

11. Rear accessory socket

12. Rear auxiliary terminals*

13. Power outlet (AC 115V)*

Cargo light

Located on interior side of liftgate
See Interior Lights for operation

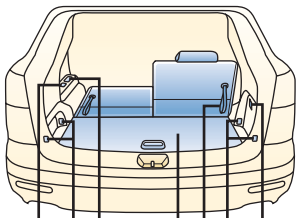

13 9 12 10 14 9 11

*Denotes optional equipment

† See Owner's Manual

Gas cap

After filling vehicle with gasoline, fully reinstall gas cap by turning clockwise until a clicking sound is heard, if gas cap is not fully installed, Check Engine light and/or gas cap indicator light may come on

For more information on Check Engine light, see Owner's Manual

Tire economy and tips

Check tire pressure monthly when tires are cold, use a digital tire pressure gauge for accurate tire pressure measurement

Tires should be of the same type and size

Maintain correct front-end alignment and tire balance; rotate tires at 5,000 or 7,500 mile intervals; see Owner's Manual for rotation chart

Tire pressure

Decal on Driver's B-pillar provides tire pressure information

⚠ Tire Pressure Monitoring System (TPMS)

Warning light illuminates for a few seconds after ignition is on. If tire pressure is too low in one or more tires, warning light will illuminate and beeper will sound; flashing warning light indicates possible malfunction; dealer inspection required

Anti-lock Braking System (ABS)

ABS automatically reduces hydraulic pressure to any wheel on the verge of locking up

You may feel a slight pulsing of the brake pedal and hear a clicking noise; this tells you the ABS is functioning properly; increase pressure on pedal for maximum braking

💡 Tips: Maintain constant pressure on the brake pedal. Do not pump the brakes

ABS self test

A self-diagnostic test is performed when starting; you may feel some brake pedal pulsation and hear some noise, this is normal

Traction Control System (TCS)

Enhances traction and safety by regulating engine torque. When TCS detects drive wheel slippage it lowers engine torque to prevent loss of traction

Dynamic Stability Control (DSC)

Controls braking and engine torque in conjunction with ABS and TCS to help control side slip on slippery surfaces or during sudden or evasive maneuvering

Roll Stability Control (RSC)

System determines when corrective action is needed; by controlling engine torque and braking on each wheel

Always check the Owner's Manual for more operating information and safety features

Driving Tips

Under Hood

UNDER HOOD

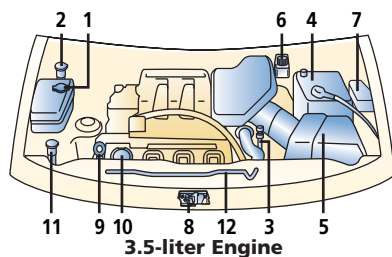

3.5-liter Engine

1. Engine coolant reservoir

Level should be between COLD FILL RANGE indicator marks
⚠️ WARNING: Never remove coolant reservoir cap while engine is running or hot; remove only when system is cool

2. Power steering fluid reservoir

Level should be between MIN and MAX lines

3. Automatic transaxle fluid level dipstick

Fluid Hot scale A
 Fluid above 150°F, level must be between full and low
Fluid Hot scale B
 Cold fluid below 70°F should be close to, but not above bottom notch on dipstick

4. Battery

5. Air filter

6. Brake fluid reservoir
 Fill to MAX mark with DOT 3 fluid; check with cap on

7. Fuse block panel
 Push latch in; lift cover

8. Hood latch
 Pull up to release hood

9. Engine oil dipstick
 Fluid should be between max. and min. on dipstick; do not fill above max.

10. Engine oil filler cap
 SAE 5W-20

11. Windshield washer fluid reservoir
 Fill with windshield washer fluid

12. Hood support rod
☀️ Tip: Check all fluids with vehicle parked on a level surface and engine off unless otherwise stated

Break-in period

First 600 miles: Avoid heavy braking and acceleration; drive at varying road and engine speeds; engine should not exceed 3500 rpm in Park or Neutral

☀️ Tip: Follow the same procedures with newly overhauled engine or when brakes are replaced

Maintenance notes:

Rotate tires every 7,500 miles or sooner if needed
 Replace cabin air filter every 25,000 miles or 24 months
 Replace spark plugs every 100,000 miles
 Inspect drive belts every 105,000 miles; replace every 150,000 miles
 Replace (FL22) engine coolant at 120,000 miles

⚠️ WARNING: Using coolant other than FL22 requires more frequent maintenance intervals

NORMAL SERVICE INTERVALS

7,500 miles	A				
15,000 miles	A		F		
22,500 miles	A				
30,000 miles	A B		E F		
37,500 miles	A	C			
45,000 miles	A			F G	
52,500 miles	A				
60,000 miles	A B		D E F		
67,500 miles	A				
75,000 miles	A	C		F	
82,500 miles	A				
90,000 miles	A B		E F G		

☀️ Tip: For additional service intervals and complete details, see Owner's Manual

*Denotes optional equipment
 †See Owner's Manual

- A. Replace: Engine oil and filter†
 Lubricate: All locks and hinges
- B. Inspect: Fuel lines and hoses, brake lines, hoses and connections, steering operation and linkages, front and rear suspension and ball joints, drive-shaft dust boots
- C. Replace: Air filter
- D. Inspect: Hoses and tubes for emission system
 Replace: Engine coolant (Other than FL22)
- E. Tighten: Bolts and nuts on chassis and body
- F. Inspect: Disc brakes
- G. Inspect: Exhaust system and heat shields

☀️ Tip: For severe driving conditions, Owner's Manual recommends changing oil and filter at 5,000† miles

Always check the Owner's Manual for more operating information and safety features