



NAVIGATION SYSTEM

OWNER'S MANUAL

Table of contents

1 Warnings and Safety information	4
2 Getting started	5
2.1 Before using the navigation system	5
2.2 Navigation menu	7
2.3 Buttons and other controls on the screen	9
2.3.1 Using keyboards	9
2.3.2 Commander Switch Operation	10
2.4 Map screen	12
2.4.1 Navigating on the map	12
2.4.2 Position markers	14
2.4.2.1 Selected map location (Cursor) and selected map object	14
2.4.3 Objects on the map	14
2.4.3.1 Streets and roads	14
2.4.3.2 Turn preview and Next street	15
2.4.3.3 Lane information and Signposts (Type A)	17
2.4.3.4 Lane information (Type B)	18
2.4.3.5 Junction view	19
2.4.3.6 Highway exit information	20
2.4.3.7 Elements of the active route	21
2.4.4 Manipulating the map	22
2.4.5 Checking the details of the current position (Where Am I?)	24
2.5 Voice Recognition	26
2.5.1 Voice command list	28
3 On-road navigation	29
3.1 Selecting the destination of a route	29
3.1.1 Entering an address or a part of the address	30
3.1.1.1 Entering an address	30
3.1.2 Selecting the destination from the POI (point of interest)	37
3.1.2.1 Quick search for a POI (point of interest)	37
3.1.2.2 Searching for Help nearby	44
3.1.2.3 Searching for a POI (point of interest) by category	49
3.1.2.4 Searching for a POI (point of interest) by name	55
3.1.3 Selecting a map location as the destination	60
3.1.4 Selecting the destination from your Favorites	64
3.1.5 Selecting a recent destination from the History	66

3.1.6	Entering the coordinate of the destination.....	72
3.1.7	OneBox search.....	76
3.2	Checking route parameters and accessing route related functions	81
3.3	Modifying the route	83
3.3.1	Selecting a new destination when already having a route: New Route, Waypoint or Final Destination	83
3.3.2	Editing the list of destinations (Edit Route)	85
3.3.3	Checking route alternatives when planning the route	88
3.3.4	Changing the road types used in route planning	91
3.4	Saving a location as a Favorite destination.....	95
3.4.1	Editing the details of a Favorite destination.....	96
4	Reference Guide.....	97
4.1	Concepts.....	97
4.1.1	Smart Zoom	97
4.1.2	Route calculation and recalculation	97
4.1.3	Speed limit warning (Only some countries and regions)	99
4.1.4	Traffic information in route planning (Only some countries and regions)	100
4.1.4.1	Historical traffic	101
4.1.5	SiriusXM Travel Link® (Only some models)	102
4.1.5.1	Traffic Plus	102
4.1.5.2	Weather Radar.....	104
4.2	Settings menu	105
4.2.1	Guidance Settings	106
4.2.2	Warnings Settings.....	107
4.2.3	Traffic Settings.....	108
4.2.4	Route Settings.....	110
4.2.5	Map Settings.....	114
4.2.6	Visual Guidance settings	116
5	Glossary	117
6	End-User Terms	119

1 Warnings and Safety information

The navigation system guides you to your destination using the GNSS (GPS+GLONASS) receiver. The navigation system does not transmit your GNSS (GPS+GLONASS) position and you cannot be tracked.

It is important that you look at the display only when it is safe to do so. If you are the driver of the vehicle, we recommend that you operate the navigation system before you start your journey. Plan the route before your departure and stop if you need to change the route.

Drive the vehicle according to the road signs and the road shape. If you deviate from the recommended route, the navigation system changes the instructions accordingly.

For more information, consult the End-User Terms (page 119).

2 Getting started

2.1 Before using the navigation system

To use the navigation system, the SD card containing the map information needs to be inserted in the SD card slot.

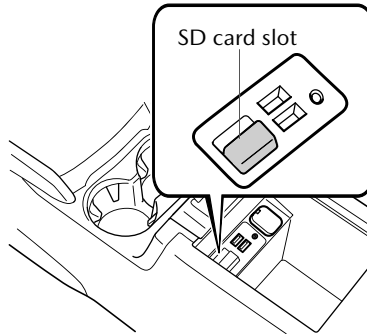

The location of the SD card slot differs depending on the vehicle model.

1

2

3

4

5

6

When inserting the SD card, never move the slider on the side of the SD card to the LOCK position. If the slider is set to LOCK, the SD card cannot be read and the navigation system will not operate.

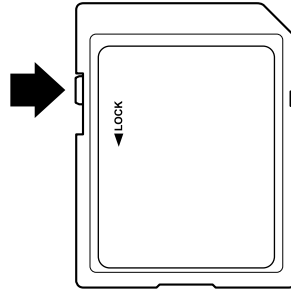

This SD card is valid for use in only one vehicle. If the SD card is used first in one vehicle and then in another, the navigation system for either one of the vehicles may become inoperable.

SD card/map updates

Map and data stored on the SD card can only be modified using the Mazda Toolbox application. All details concerning the Mazda Toolbox application and the method for updating the maps can be found on your local Mazda website. We strongly recommend that you make a backup copy of the SD card data using the Mazda Toolbox application before starting the map updating process. If a problem occurs while updating the SD card, it could result in the loss of all the content on the card (such as map data, software, additional services).

The only way to restore lost data is to use the Mazda Toolbox application and the backup copy of the SD card made beforehand.

NOTE

Insert and remove the SD card with the ignition switched off.

2.2 Navigation menu

Type A

You can reach all parts of the navigation system from the Navigation menu. Press the commander knob with the map screen open to display the navigation menu.



You have the following options:

- **Add Destination:**
Select your destination by entering an address or selecting a POI (point of interest), a location on the map or one of your Favorite destinations. You can also look up your recent destinations from the Smart History by entering the coordinates.
- **Cancel Route:**
Cancels waypoint/route.
- **Route Options:**
Changes and displays information regarding the set routes.
- **Split Screen:**
Switches the operation target to the right screen when 2 screens are displayed.
- **Map View:**
The map view mode can be changed (2D/2D North up/3D).
- **Travel Information:**
Displays facility/services and traffic information.
- **Navigation Settings:**
Switches to the Settings screen where you change navigation settings.
- **Mute Guidance:**
Enables or disables voice guidance.

NOTE

Some functions are not available depending on some countries and regions.

Type B

You can reach all parts of the navigation system from the Navigation menu. Press the commander knob with the map screen open to display the navigation menu.

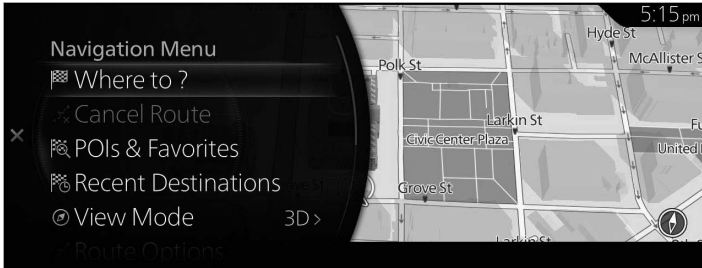

You have the following options:





- **Where to ?:**
Search for the destination based on the input characters, address, and latitude and longitude.
- **Cancel Route:**
Cancels waypoint/route.
- **POIs & Favorites:**
POI Categories, Favorites, HOME, and WORK can be selected.
- **Recent Destinations:**
A destination from the past history can be selected.
- **View Mode:**
The map view mode can be changed (2D/2D North up/3D).
- **Route Options:**
Changes and displays information regarding the set routes.
- **Side Panel:**
Switches the operation target to the right screen when 2 screens are displayed.
- **Travel Information:**
Displays facility/services and traffic information.
- **Navigation Settings:**
Switches to the Settings screen where you change navigation settings.
- **Mute Guidance:**
Enables or disables voice guidance.

NOTE

Some functions are not available depending on some countries and regions.

2.3 Buttons and other controls on the screen

2.3.1 Using keyboards

Task	Instruction
Correcting your entry on the keyboard	Select  to remove the unneeded character(s).
Entering a space, for example between a first name and a family name or in multi-word street names	Select  .
Entering upper and lower case letters	When entering a text, the first character appears in upper case while the rest of the text is in lower case. Select  to enter an upper case letter or select twice to turn on Caps Lock. Select again and lower case letters return.
Finalizing the keyboard entry	Select  . <ul style="list-style-type: none">• Accepting the suggested search result• Saving your input• Opening the list of search results
Switching the displayed language	Select  . Select the language you want to use.

1

2

3

4

5

6

2.3.2 Commander Switch Operation





The commander switch can be used to switch to each function and to operate each function.

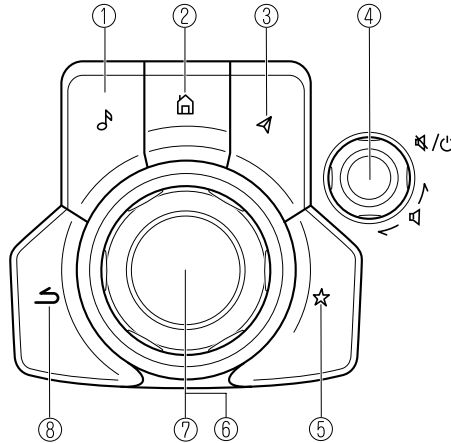



NOTE

For safety reasons, some operations are disabled while driving the vehicle.



The shape of the switches varies depending on the vehicle model.

No.	Item	Explanation
1		Entertainment button: The audio source screen last used is displayed.
2		Home button: Displays the home screen.
3		Navigation button: Displays the navigation screen.
4		Volume knob: Adjust the volume by turning the volume knob. If you adjust the volume during a voice guidance, the volume of the voice guidance changes.

No.	Item	Explanation
5		Favorites button: Displays the favorites screen. Press and hold the button to store items in favorites.
6		Commander knob (selection): Rotate or tilt the commander knob to choose the function you want to use.
7		Commander knob (select): Press the commander knob to select the function you want to use.
8		Back button: Returns to previous screen.

1

2

3

4

5

6

2.4 Map screen

2.4.1 Navigating on the map

Type A



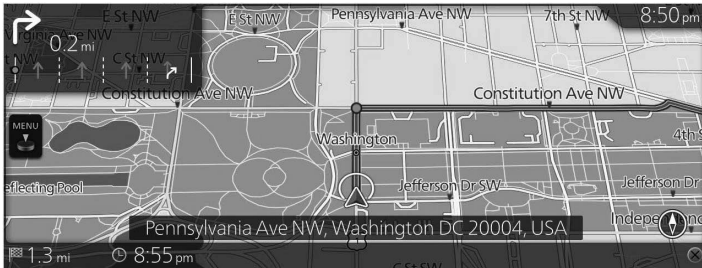

Type B



The appearance of the map will vary if you're navigating an active route or if no destination has been set.

Field	Description
<p>Type A Type B</p>  <p>*On some vehicles, the speed limit of the current road is not indicated in the center display, only the active driving display.</p>	<p>Shows the speed limit of the current road if the map contains it.</p>

Field	Description
<p>Type A</p>  <p>Type B</p> 	<p>Shows the distance you need to travel on the route before reaching your final destination.</p> <p>Shows the estimated arrival time at the final destination of the route.</p> <p>If the navigation system is capable of receiving live traffic information, the calculation takes into account traffic delays affecting your route. This estimation can be inaccurate at times.</p>

NOTE

Some functions are not available depending on some countries and regions.



- 1
- 2
- 3
- 4
- 5
- 6

2.4.2 Position markers

2.4.2.1 Selected map location (Cursor) and selected map object

You can mark a map location in the following ways:

- Select the map during route guidance.
- Select the map when asked so that the destination can be confirmed after the search is completed.
- Select the destination from the map. (page 60)

When a map location is selected, the Cursor appears at the selected point on the map. A symbol  (Type A) /  (Type B) with a combined crosshair and circle is displayed for easy visibility of any map scale size.

The location of the Cursor can be used as the destination of the route. You can search for a POI (point of interest), or you can save it as one of your Favorites destinations.

You can also select some of the objects on the map. You can then get information about this object or use it as a route point.



Some functions are not available depending on some countries and regions.

2.4.3 Objects on the map

2.4.3.1 Streets and roads

The navigation system shows the roads in different widths and colors so that they can be easily identified. A highway/freeway will be thicker and a different color than a small street.

2.4.3.2 Turn preview and Next street

When navigating a route, the top section of the Map screen shows information about the next maneuver, street or city.

There is an area at the top left part of screen which indicates the next operation. Displays both the event type (such as turning, detouring, exiting expressways) and the distance from the current position.

When the next event approaches, the second event is displayed using a small icon. If there is no second event, only the next event is displayed.

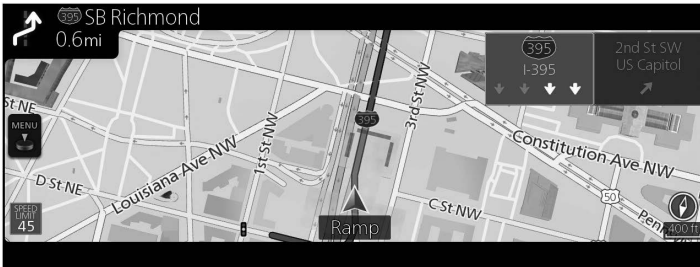

Type A



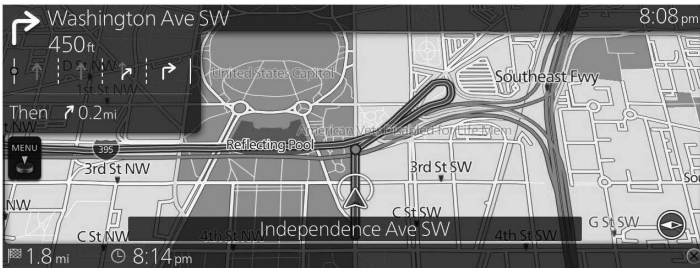











Type B



The same symbols are used in both fields:

Icon	Description
	Turn left.
	Turn right.
	Turn back.

Icon	Description
	Bear right.
	Turn sharp left.
	Keep left.
	Continue straight in the intersection.
Type A 	Go right on the roundabout, 3rd exit (next maneuver).
Type B 	Go right on the roundabout, 7th exit (next maneuver).
	Enter highway/freeway.
	Exit highway/freeway.
	Board ferry.
	Leave ferry.
	Approaching a waypoint.
	Approaching the destination.

2.4.3.3 Lane information and Signposts (Type A)

When navigating on multilane roads, it is important to take the appropriate lane in order to follow the recommended route. If lane information is available in the map data, the navigation system displays the lanes and their directions using small arrows at the bottom of the map. Highlighted arrows represent the lanes and direction you need to take.

Lane guidance is provided if there is map information. Signposts are displayed at the top of the map. The color and style of the signposts are similar to the real ones you see above road or by the roadside. They show the available destinations and the number of the road the lane leads to.

When navigating a route, only the signpost that points to the lane(s) to be taken is displayed in bright colors; all others are darker. All signposts and lane guidance arrows are displayed in vivid colors while driving (when there is no active route).



1

2

3

4

5

6

2.4.3.4 Lane information (Type B)

When navigating on multilane roads, it is important to take the appropriate lane in order to follow the recommended route. If lane information is available in the map data, the navigation system displays the lanes and their directions using small arrows at the bottom of the map. Highlighted arrows represent the lanes and direction you need to take.

Lane guidance is provided if there is map information.

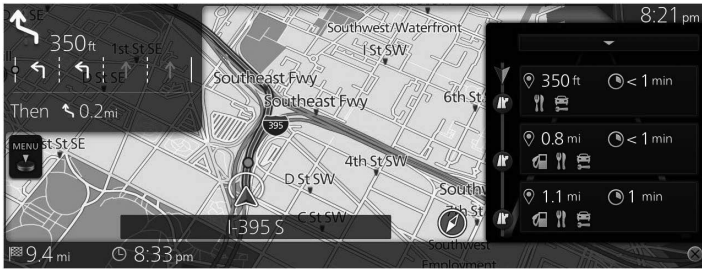

2.4.3.5 Junction view

If you are approaching a highway/freeway exit or a complex intersection and the needed information exists, the map is replaced with a 3D view of the junction. The optimum driving lane is indicated by an arrow, and road signs are displayed as additional information at the top of the screen.

Type A



Type B

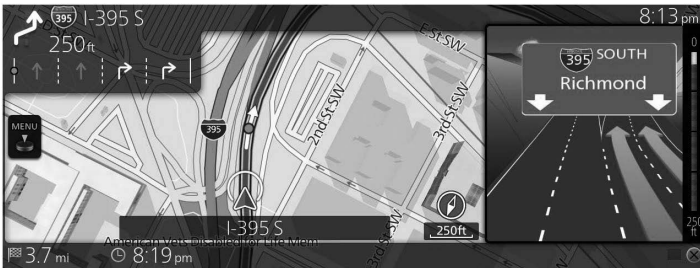

1

2

3

4

5

6

2.4.3.6 Highway exit information

This function is displayed on the side panel when driving on a highway.

Type A

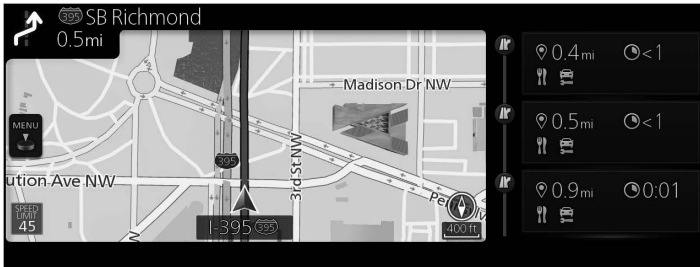

Type B





There are two types of settings for displaying the next expressway exit; one which constantly displays the next expressway exit while traveling on an expressway, or the other which displays the next expressway exit only when the menu panel is open.

You can change the settings in Visual Guidance settings (page 116).

2.4.3.7 Elements of the active route

The navigation system shows the route in the following way:

Symbol	Name	Description
Type A Type B 	Current car position marker	If there is a road close by, a Red-colored arrow symbol moves to the road which is the closest.
	Waypoint (intermediate destination)	An intermediate destination of the route before reaching the final destination.
	Destination (end point)	The final destination of the route.
—	Route color	The route always stands out with its color on the map, both in daytime and in nighttime mode.
—	Streets and roads that are excluded from the navigation	You can choose whether you want to use or avoid certain road types (page 110). However, when the navigation system cannot avoid such roads, the route will include them and it will show them in a color that is different from the route color.
—	Streets and roads that are affected by traffic events	Road segments may be affected by traffic events received. These streets and roads are displayed in an alternate color, and small symbols displayed along the route show the type of traffic event.

NOTE

Some functions are not available depending on some countries and regions.

2.4.4 Manipulating the map

You can scroll a map and zoom-in/zoom-out of it using the commander knob while the screen is not displaying a menu.



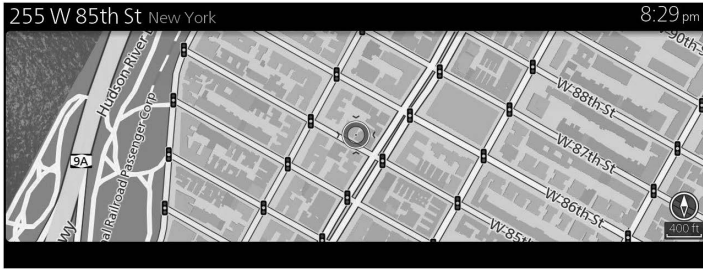

Type A



Type B



Action	Commander operation	Description
Scrolling the map	Tilt (left/right/up/down)	You can move the map in any direction.
Zooming in and out	Rotate clockwise/Rotate counterclockwise	Changes how much of the map is displayed on the screen. The navigation system uses high-quality vector maps that let you examine the map at various zoom levels, always with optimized content. Map scaling has a limit in 3D map view mode. If you zoom out further, the map switches to 2D view mode.

Action	Commander operation	Description
Open/close	Open: Push Close:  button/Tilt (left)	The option menu is displayed on the lower part of the screen. Hides the displayed option menu if the option menu has been displayed.
Select destination	Push	Press the commander knob to set the cursor's location as the new destination. The route is automatically calculated.
Return to normal navigation	 button	Returns the map to its original GNSS (GPS+GLONASS) position. Automatic map rotation is also re-enabled. The cursor disappears and navigation continues.
Perspective angle mode	Rotate clockwise/Rotate counterclockwise	You can change the angle of perspective on a map. Selects Rotate Map  or Tilt Map  .

- 1
- 2
- 3
- 4
- 5
- 6

2.4.5 Checking the details of the current position (Where Am I?)

This screen contains information about the current position (or about the last known position if GNSS (GPS+GLONASS) reception is not available).

Type A

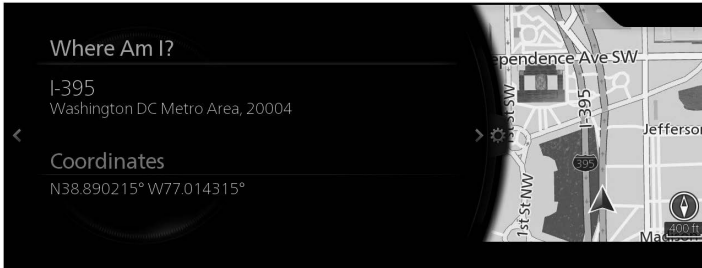

Type B



You can access this screen from the map in one of the following ways:

1. Press the commander knob with the map screen open to display the menu, and select "Travel Information".
2. Select "Where Am I?".

Type A



Type B



1

2

3

4



5

6

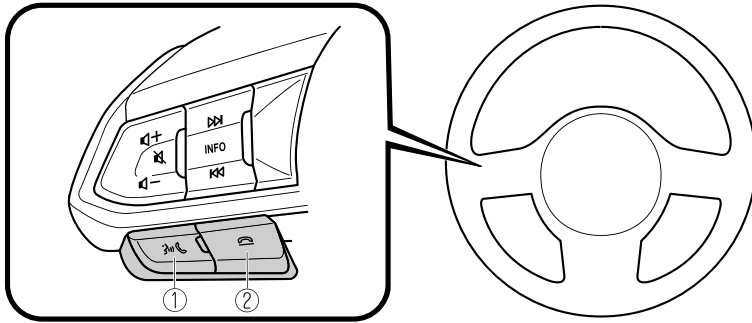
2.5 Voice Recognition



The shape of the switches differs depending on the vehicle model.

No.	Item	Explanation
1		<p>Talk/Pick-up button: When the button is pressed, the voice recognition top screen is displayed and the voice recognition is activated.</p> <p>(While voice guidance is being announced) Press the button to skip the voice guidance.</p>
2		<p>Hang-up button: Press the button to end the voice recognition.</p>

Voice recognition activation

When the talk/pick-up button on the audio remote control switch is pressed, the voice recognition top screen is displayed.

NOTE

The Mazda Connect voice recognition is not active while Apple CarPlay™ or Android Auto™ is connected, the talk/pick-up button will activate Siri or Android Auto™ voice recognition instead.

Commands usable at any time

“Help” - Can be used to check for usable voice commands.

“Back” - Returns to the previous screen. When a voice command is spoken while on the telephone number input screen, the content that was previously input is deleted.

“Cancel” - The voice recognition is ended.

Ending voice recognition

Do any one of the following operations:

- Press the hang-up button.
- Press and hold the talk/Pick-up button.
- Say the word, "Cancel".

Convenient operating tips for using the voice recognition function

Examples of effective voice commands in various categories are displayed on the voice recognition top screen.

It would be convenient to know these usable voice commands in advance.

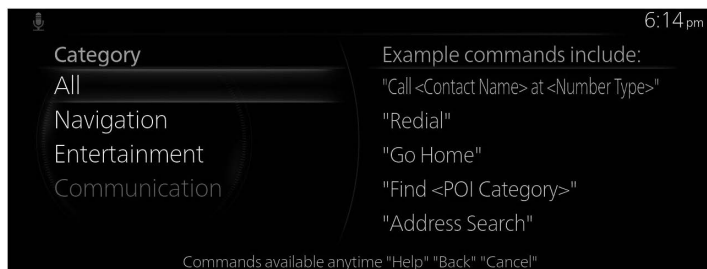

NOTE

- The voice commands indicated in this manual are some examples of usable voice commands.
- When the Barge-In setting is on, voice commands can be made even while the voice guidance is being announced.
For details on Barge-In, refer to the Settings section in the Mazda Connect Owner's Manual.

To prevent mistaken voice recognition, be aware of the following points:

- Speaking in a slightly louder voice will improve voice recognition, but an excessively loud voice is unnecessary. Try to speak in a slightly louder voice than when talking to other passengers in the vehicle.
- You do not need to speak slowly. Speak at a normal speed.
- Speak clearly, without pausing between words or numbers.
- Voice commands other than those specified, cannot be recognized. Speak in the wording specified by the voice commands.
- It is not necessary to face the microphone or approach it. Speak the voice commands while maintaining a safe driving position.
- Make sure that the air flow from the air conditioner is not blowing on the microphone.

- When making voice commands during a voice guidance, speak in a slightly louder voice. But, an excessively loud voice is unnecessary.
- If the voice recognition is poor with the guidance volume set to high, set the Barge-In to OFF.

2.5.1 Voice command list

Some voice command examples corresponding to the voice recognition function

The specified name and number are put into the {}.

Common

- Back
- Help (You can listen to help guidance at each screen.)
- {Line Number} (You can select the line number on the screen.)
- Next Page
- Previous Page
- Cancel

Navigation

- Go Home
- Address Search
- Show Previous Destinations
- Cancel Route
- Delete Destination
- Show/Hide {POI category name}
- Find {POI Category}
- POI Categories

3 On-road navigation

You can set up your route in different ways:

If you need a route for immediate navigation, you can select the destination and start navigating to it right away (normal navigation).

You can plan routes with multiple destinations. Select the first destination. Then select a second destination and add it to your route to create a multi-point route. You can add as many destinations to your route as you like.

3.1 Selecting the destination of a route

The navigation system offers you several ways of choosing your destination:

- Enter a full address or a part of an address (page 30).
- Select a POI (point of interest) from a database as your destination (page 37).
- Searches the destination from the map (page 60).
- Use a previously saved Favorite destination (page 64).
- Select a location from the History of previously used destinations (page 66).
- Enter the coordinate of the destination (page 72).
- Free word search (OneBox search) (page 76).



There are other convenient functions.

1

2

3

4

5

6

3.1.1 Entering an address or a part of the address

If you know at least a part of the address, it is the quickest way to select the destination of the route.

Using the same screen, you can find an address by entering:

- Destination address



If an address or part of a facility name is input, a search candidate list including the input characters is displayed. The greater the number of characters input the more the list is refined.

3.1.1.1 Entering an address

Type A

To enter an address as the destination, do as follows:

1. Press the commander knob with the map screen open to display the menu and select "Search" from "Add Destination".
2. Select "Address Entry".
3. By default, the navigation system proposes the country and city where you are. If needed, select "Country, State/Province", enter the first few letters of the country name on the keyboard, and select one country from the list of results.



4. If needed, select a new city:
 - a. Select "City".
 - b. Start entering the name of the city on the keyboard.
 - c. Find the city you need:
 - The most likely city name is always shown in the input field. To accept it, select .
 - If the desired name does not show up, the names that match the string appear in a list after entering a couple of characters. Select the city from the list.

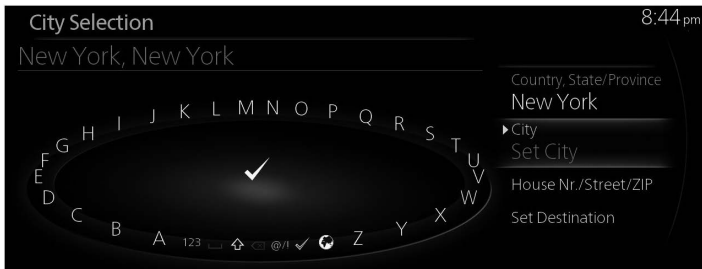

1

2

3

4

5

6

5. Enter the specific street and house number:
- Select "House Nr./Street/ZIP".
 - Start entering the street name on the keyboard.
 - Find the street you need:
 - The most likely street name is always shown in the input field. To accept it, select .
 - If the desired name does not show up, the names that match the string appear in a list after entering a couple of characters. Select the street from the list.

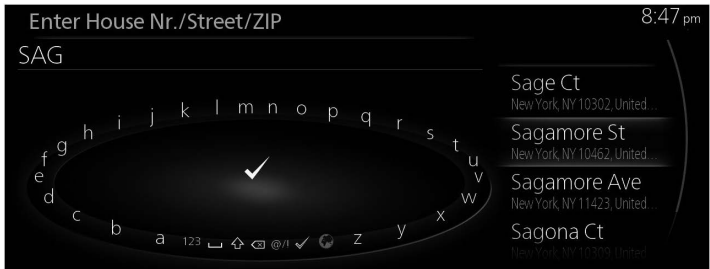

6. The selected location is shown on the map.
The system transitions to the next screen by selecting “Navigate Here”, or it returns to the previous screen by tilting the commander knob to the left. The destination can be changed to anywhere on the map by tilting the commander knob to the right and using the cursor.

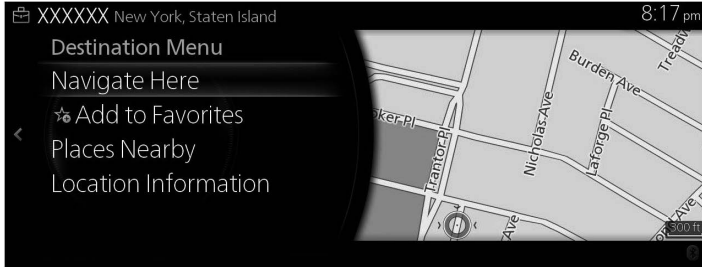

NOTE

- “Places Nearby”: You can search for POI (point of interest) around the selected location.
- “Add to Favorites”: The selected location can be registered to Favorites.

7. Navigation starts if “Start Guidance” is selected, or after 10 seconds of no user interaction.
Additionally, the route can be revised by selecting other options.



Type B

To enter an address as the destination, do as follows:

1. Press the commander knob with the map screen open to display the menu and select "Search" from "Where to?".

NOTE

The menu is not displayed even if the commander knob is pressed during map scrolling.

2. Select "Address Entry".
3. By default, the navigation system proposes the country and city where you are. If needed, select "Country, State/Province", enter the first few letters of the country name on the keyboard, and select one country from the list of results.



4. If needed, select a new city:
 - a. Select "City".
 - b. Start entering the name of the city on the keyboard.
 - c. Find the city you need:
 - The most likely city name is always shown in the input field. To accept it, select .
 - If the desired name does not show up, the names that match the string appear in a list after entering a couple of characters. Select the city from the list.



5. Enter the specific street and house number:
 - a. Select "ZIP/Street/House Nr."
 - b. Start entering the street name on the keyboard.
 - c. Find the street you need:
 - The most likely street name is always shown in the input field. To accept it, select .
 - If the desired name does not show up, the names that match the string appear in a list after entering a couple of characters. Select the street from the list.



1

2

3

4

5

6

- The selected location is shown on the map.
The system transitions to the next screen by selecting “Navigate Here”, or it returns to the previous screen by tilting the commander knob to the left.

If the user makes no operation for 10 seconds, the navigation starts.

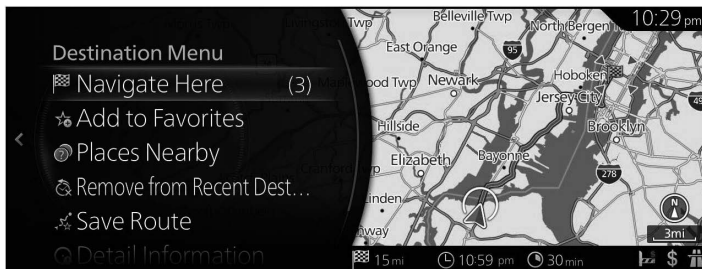

NOTE

- “Places Nearby”: You can search for POI (point of interest) around the selected location.
- “Add to Favorites”: The selected location can be registered to Favorites.

3.1.2 Selecting the destination from the POI (point of interest)

You can select your destination from the POI (point of interest) included with the navigation system.

Using the same screen, you can find a POI (point of interest) in different ways:

- You can quickly find a nearby POI (point of interest) by its name using the Quick search feature.
- You can find frequently searched types of POI (point of interest) with only a few screen selects using the Preset search feature.
- You can search for a POI (point of interest) by its category.
- You can search for a POI (point of interest) by its name.

3.1.2.1 Quick search for a POI (point of interest)

Type A

If the name for a POI (point of interest) is input, a search candidate list is displayed. One destination among the candidates can be selected.

- Along the recommended route if it exists.
- Around your current location if there is no destination given.

Start the Quick search function:

1. Press the commander knob with the map screen open to display the menu, and select "Add Destination".
2. Select "More Categories" under "POI Categories".

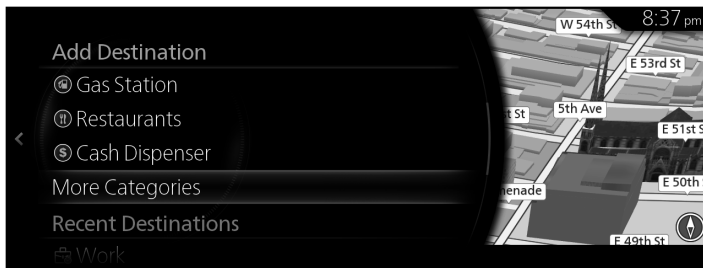

3. Select "Search".

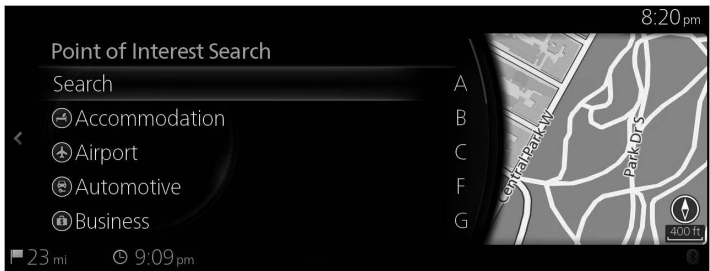

4. Using the keyboard, enter the name of the POI (point of interest).



NOTE

If an address or part of a facility name is input, a search candidate list including the input characters is displayed. The greater the number of characters input the more the list is refined.

5. After entering a few letters, select to open the list of POI (point of interest) with names containing the entered character sequence.

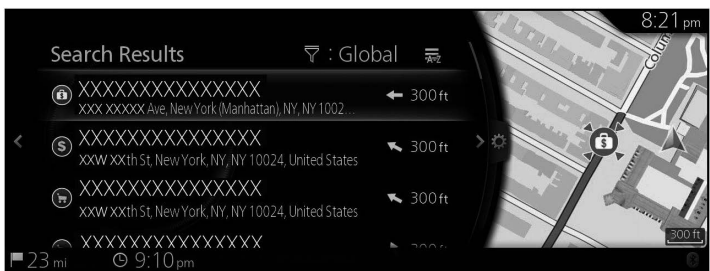

6. Tilt the commander knob to the right and display the option panel to reorder the list from “Sort By” and to limit the area from “Search Area”.

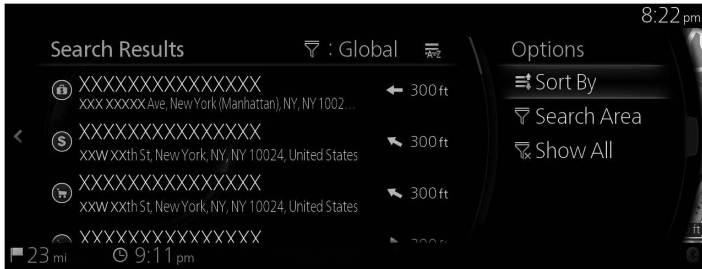

Search Area:

- You can search the area around your current position by selecting “Nearby”. (The result list will be ordered by the distance from this position.)
 - Select “In a City” to search for a place within a selected city. (The result list will be ordered by the distance from the center of the selected city.)
 - Select “Along Route” to search along the active route, and not around a given point. This is useful when you search for a later stopover that results in a minimal detour only, such as searching for upcoming gasoline stations or restaurants. (The result list will be ordered by the length of the necessary detour.)
 - You can search the area around the final destination by selecting “At Destination”. (The result list will be ordered by the distance from this position.)
 - You can search the area around the next waypoint by selecting “At Next Waypoint”. (The result list will be ordered by the distance from this position.)
7. Select a destination from the list.

1

2

3

4

5

6

- The selected location is shown on the map.
The system transitions to the next screen by selecting “Navigate Here”, or it returns to the previous screen by tilting the commander knob to the left. The destination can be changed to anywhere on the map by tilting the commander knob to the right and using the cursor.



NOTE

- “Places Nearby”: You can search for POI (point of interest) around the selected location.
- “Add to Favorites”: The selected location can be registered to Favorites.

- Navigation starts if “Start Guidance” is selected, or after 10 seconds of no user interaction.
Additionally, the route can be revised by selecting other options.



Type B

If the name for a POI (point of interest) is input, a search candidate list is displayed. One destination among the candidates can be selected.

- Along the recommended route if it exists.
- Around your current location if there is no destination given.

Start the Quick search function:

1. Press the commander knob with the map screen open to display the menu, and select "POIs & Favorites".
2. Select "More Categories" under "POI Categories".

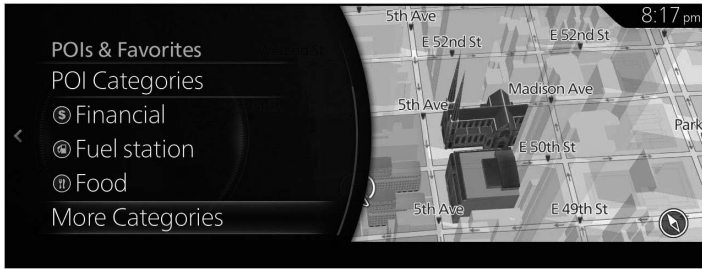

3. Select "Search".

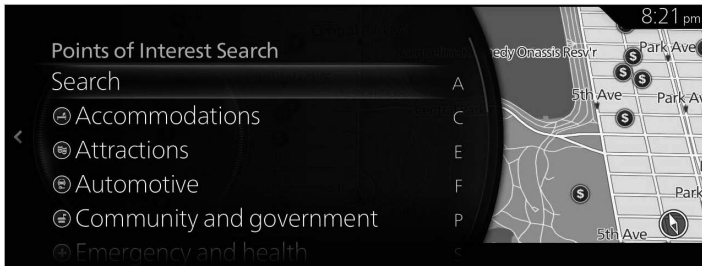

4. Using the keyboard, enter the name of the POI (point of interest).

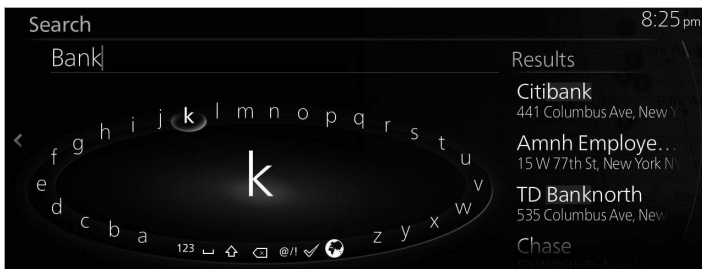

NOTE

If an address or part of a facility name is input, a search candidate list including the input characters is displayed. The greater the number of characters input the more the list is refined.

5. After entering a few letters, select to open the list of POI (point of interest) with names containing the entered character sequence.

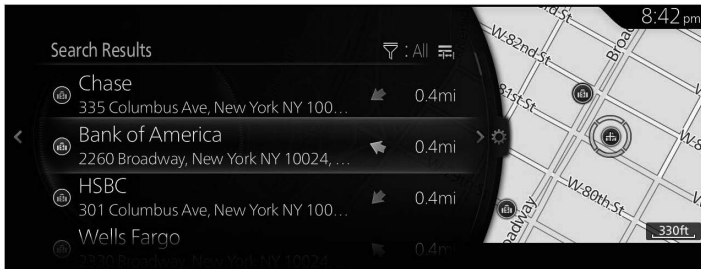

6. Tilt the commander knob to the right and display the option panel to reorder the list from "Sort By" and to limit the area from "Search Area".

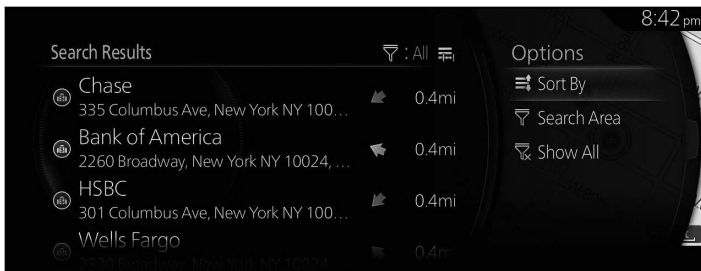

Search Area:

- You can search the area around your current position by selecting "Nearby". (The result list will be ordered by the distance from this position.)
- Select "In a City" to search for a place within a selected city. (The result list will be ordered by the distance from the center of the selected city.)

- Select “Along Route” to search along the active route, and not around a given point. This is useful when you search for a later stopover that results in a minimal detour only, such as searching for upcoming gasoline stations or restaurants. (The result list will be ordered by the length of the necessary detour.)
 - You can search the area around the final destination by selecting “At Destination”. (The result list will be ordered by the distance from this position.)
 - You can search the area around the next waypoint by selecting “At Next Waypoint”. (The result list will be ordered by the distance from this position.)
7. Select a destination from the list.
 8. The selected location is shown on the map.
The system transitions to the next screen by selecting “Navigate Here”, or it returns to the previous screen by tilting the commander knob to the left.
If the user makes no operation for 10 seconds, the navigation starts.

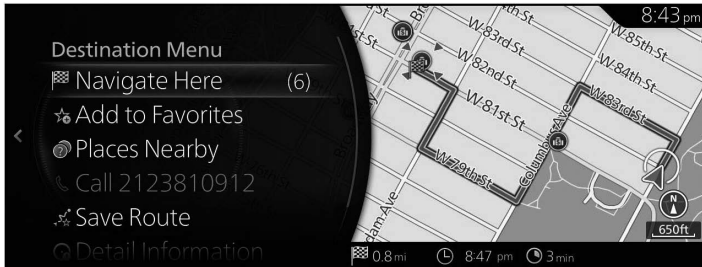

NOTE

- “Places Nearby”: You can search for POI (point of interest) around the selected location.
- “Add to Favorites”: The selected location can be registered to Favorites.

3.1.2.2 Searching for Help nearby

Type A

The Preset search feature lets you quickly find the most frequently selected types of Places.

1. Press the commander knob with the map screen open to display the menu, and select "Travel Information".
2. Select "Help Nearby".



3. Preset search categories appear, all for searching around the current position (or around the last known position if the current position is not available).

4. Tilt the commander knob to the right to display the local menu. Select any of the quick search items to get an instant list of Places.

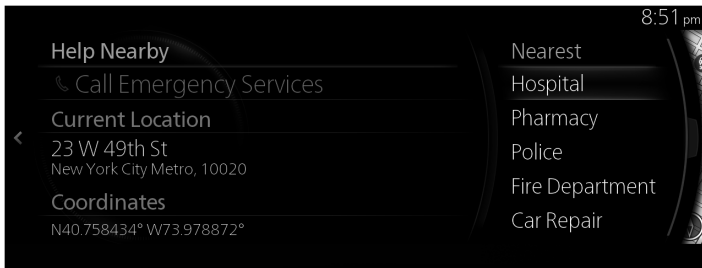
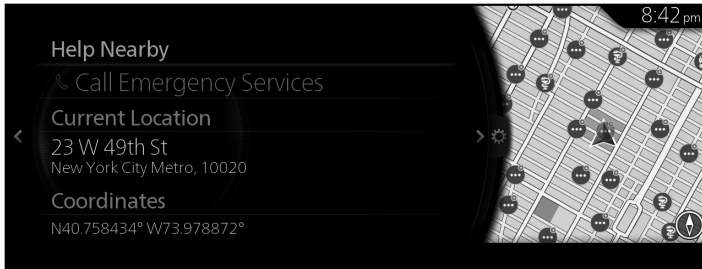

5. Select a destination from the list.
6. The selected location is shown on the map.
The system transitions to the next screen by selecting "Navigate Here", or it returns to the previous screen by tilting the commander knob to the left. The destination can be changed to anywhere on the map by tilting the commander knob to the right and using the cursor.

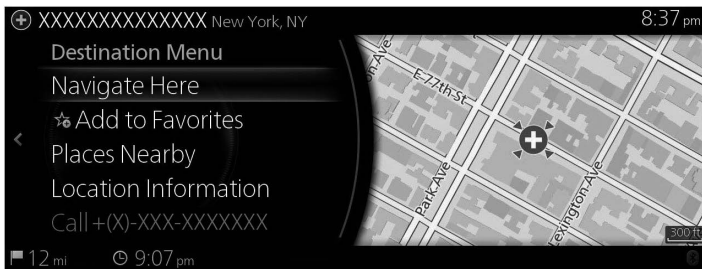

1

2

3

4

5

6

NOTE

- “Places Nearby”: You can search for POI (point of interest) around the selected location.
- “Add to Favorites”: The selected location can be registered to Favorites.

7. Navigation starts if “Start Guidance” is selected, or after 10 seconds of no user interaction.
Additionally, the route can be revised by selecting other options.



Type B

The Preset search feature lets you quickly find the most frequently selected types of Places.

1. Press the commander knob with the map screen open to display the menu, and select “Travel Information”.

NOTE

The menu is not displayed even if the commander knob is pressed during map scrolling.

2. Select “Help Nearby”.



3. Preset search categories appear, all for searching around the current position (or around the last known position if the current position is not available).
4. Tilt the commander knob to the right to display the local menu. Select any of the quick search items to get an instant list of Places.

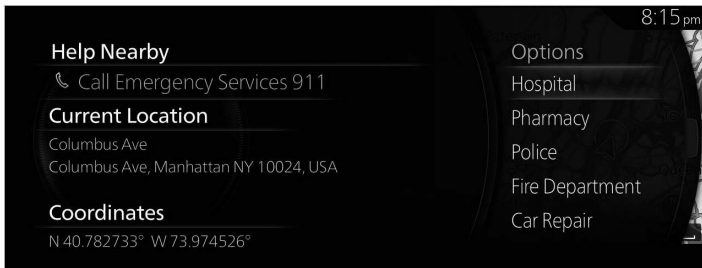
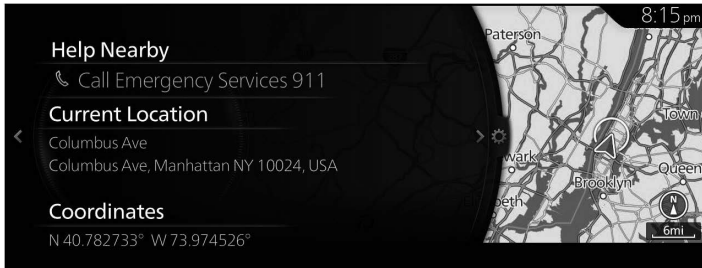

5. Select a destination from the list.

1

2

3

4

5

6

6. The selected location is shown on the map.
The system transitions to the next screen by selecting “Navigate Here”,
or it returns to the previous screen by tilting the commander knob to the left.
If the user makes no operation for 10 seconds, the navigation starts.



NOTE

- “Places Nearby”: You can search for POI (point of interest) around the selected location.
- “Add to Favorites”: The selected location can be registered to Favorites.

3.1.2.3 Searching for a POI (point of interest) by category

Type A

You can search for Places of Interest by their categories and subcategories.

1. Press the commander knob with the map screen open to display the menu, and select "Add Destination".
2. Displays a list of recently searched POI categories in "POI Categories". If any category from the list is selected, go to Step 5.



3. If the desired category is not listed, select "More Categories".

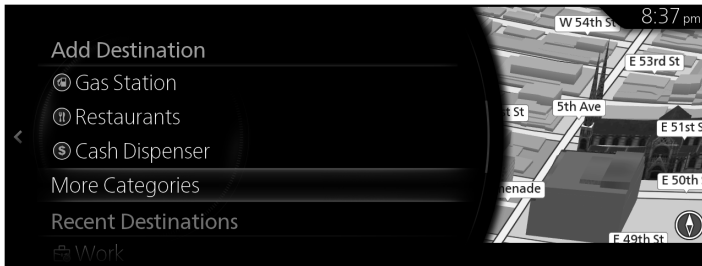

4. Select one of the main Place categories (e.g. Accommodation) to list all Places around the selected location or along the route.

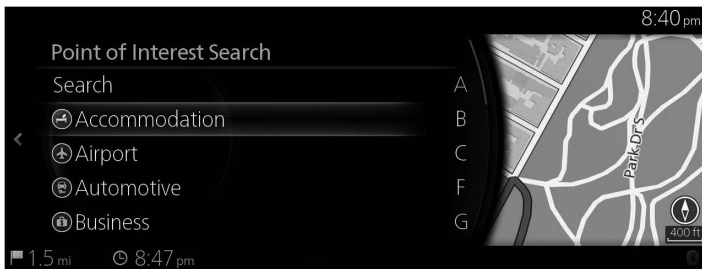

1

2

3

4

5

6

- Tilt the commander knob to the right and display the option panel to reorder the list from "Sort By" and to limit the area from "Search Area". (page 39)

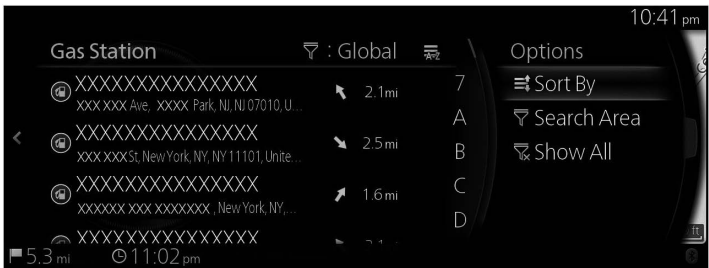
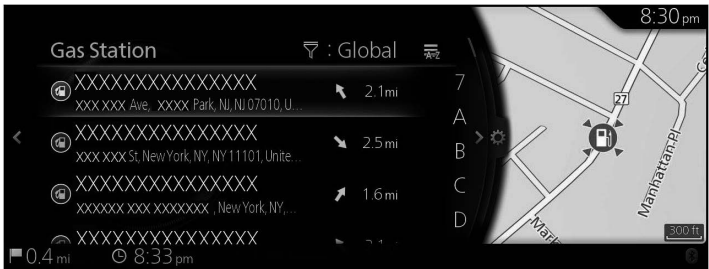

- Select a destination from the list.
- The selected location is shown on the map. The system transitions to the next screen by selecting "Navigate Here", or it returns to the previous screen by tilting the commander knob to the left. The destination can be changed to anywhere on the map by tilting the commander knob to the right and using the cursor.

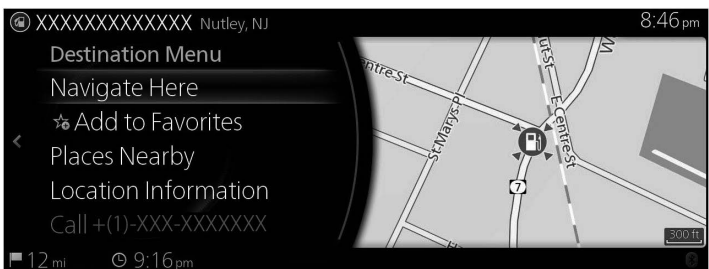

NOTE

- “Places Nearby”: You can search for POI (point of interest) around the selected location.
- “Add to Favorites”: The selected location can be registered to Favorites.

8. Navigation starts if “Start Guidance” is selected, or after 10 seconds of no user interaction.
Additionally, the route can be revised by selecting other options.



1

2

3

4

5

6

Type B

You can search for Places of Interest by their categories and subcategories.

1. Press the commander knob with the map screen open to display the menu, and select "POIs & Favorites".
2. Displays a list of recently searched POI categories in "POI Categories". If any category from the list is selected, go to Step 5.

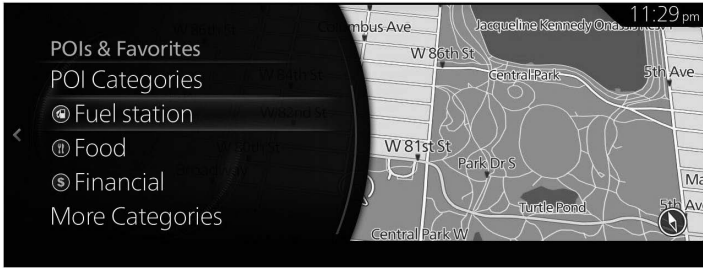

3. If the desired category is not listed, select "More Categories".

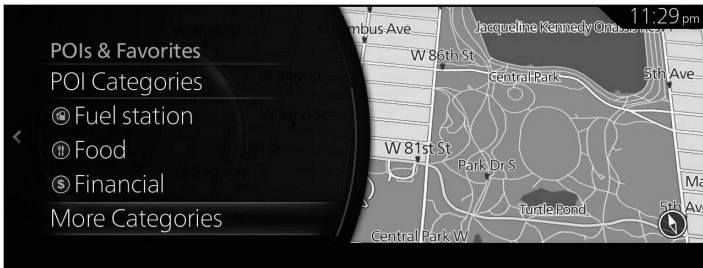

4. Select one of the main Place categories (e.g. Museum) to list all Places around the selected location or along the route.



5. Tilt the commander knob to the right and display the option panel from “Sort By” and to limit the area from “Search Area”. (page 42)

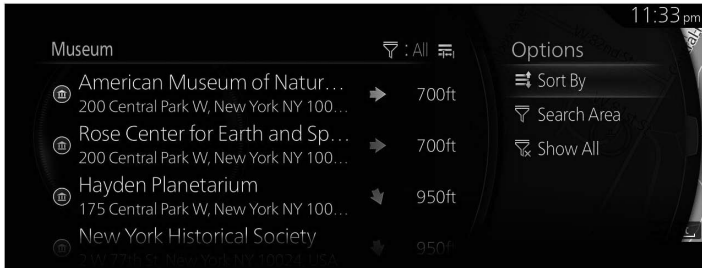
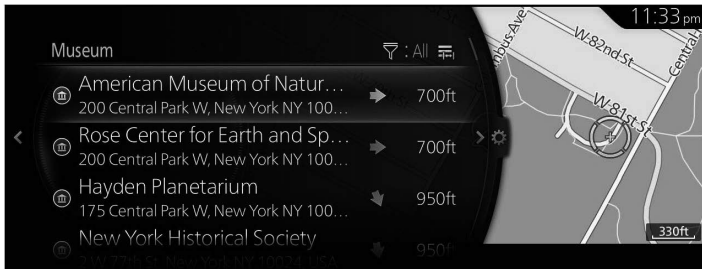

6. Select a destination from the list.

1

2

3

4

5

6

7. The selected location is shown on the map.
The system transitions to the next screen by selecting “Navigate Here”, or it returns to the previous screen by tilting the commander knob to the left.
If the user makes no operation for 10 seconds, the navigation starts.



NOTE

- “Places Nearby”: You can search for POI (point of interest) around the selected location.
- “Add to Favorites”: The selected location can be registered to Favorites.

3.1.2.4 Searching for a POI (point of interest) by name

Type A

You can search for Places of Interest by their names. You can search around different locations or along your route in the whole Place database or in one Place category or subcategory only.

1. Press the commander knob with the map screen open to display the menu, and select "Add Destination".
2. Select "More Categories" under "POI Categories".

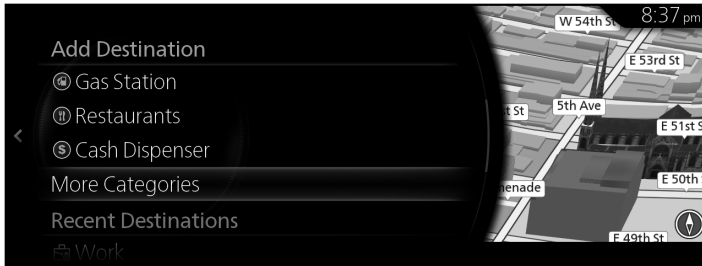

3. Select "Search".
4. Using the keyboard, start entering the name of the Place.



5. After entering a few letters, select to open the list of Places with names containing the entered character sequence.

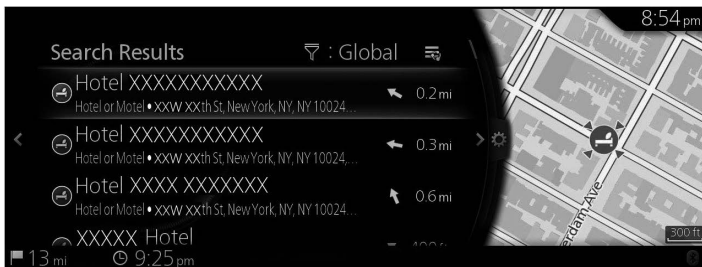

6. Tilt the commander knob to the right and display the option panel to reorder the list from "Sort By" and to limit the area from "Search Area". (page 39)

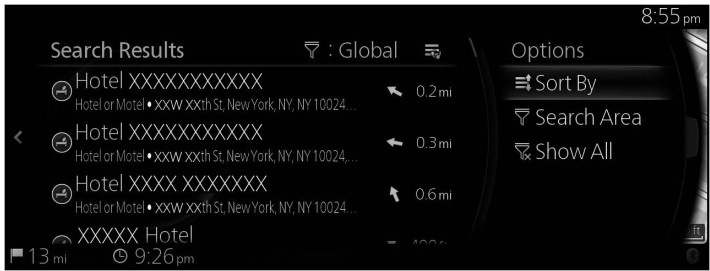

7. Select a destination from the list.
8. The selected location is shown on the map. The system transitions to the next screen by selecting "Navigate Here", or it returns to the previous screen by tilting the commander knob to the left. The destination can be changed to anywhere on the map by tilting the commander knob to the right and using the cursor.



NOTE

- "Places Nearby": You can search for POI (point of interest) around the selected location.
- "Add to Favorites": The selected location can be registered to Favorites.

- Navigation starts if “Start Guidance” is selected, or after 10 seconds of no user interaction.
Additionally, the route can be revised by selecting other options.



Type B

You can search for Places of Interest by their names. You can search around different locations or along your route in the whole Place database or in one Place category or subcategory only.

- Press the commander knob with the map screen open to display the menu, and select “POIs & Favorites”.
- Select “More Categories” under “POI Categories”.

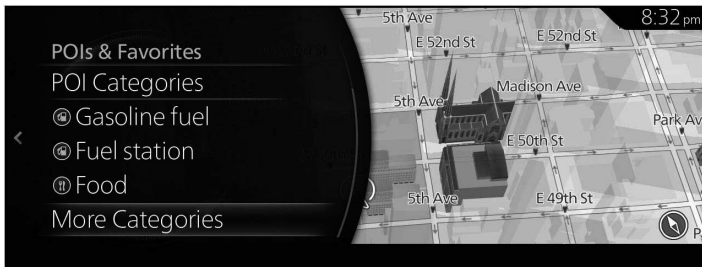

- Select “Search”.

1

2

3

4

5

6

- Using the keyboard, start entering the name of the Place.



- After entering a few letters, select to open the list of Places with names containing the entered character sequence.

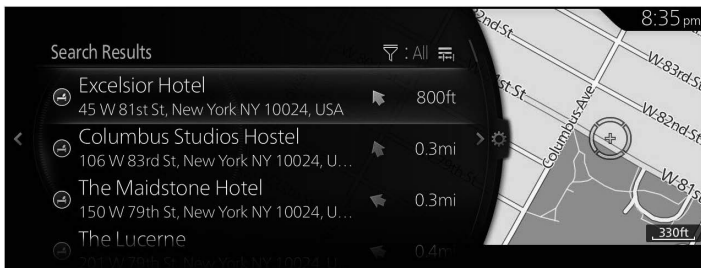

NOTE

The selection operation can also be done by tilting the commander knob to the right.

- Tilt the commander knob to the right and display the option panel to reorder the list from "Sort By" and to limit the area from "Search Area". (page 42)

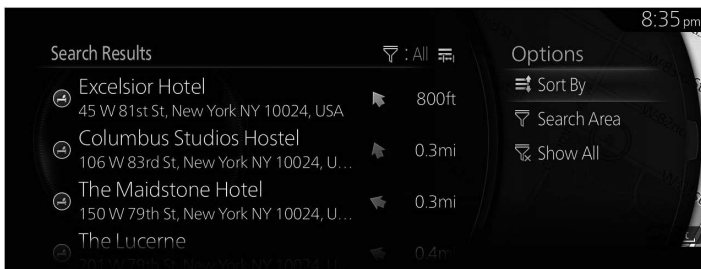

- Select a destination from the list.

8. The selected location is shown on the map.
The system transitions to the next screen by selecting “Navigate Here”, or it returns to the previous screen by tilting the commander knob to the left.

If the user makes no operation for 10 seconds, the navigation starts.

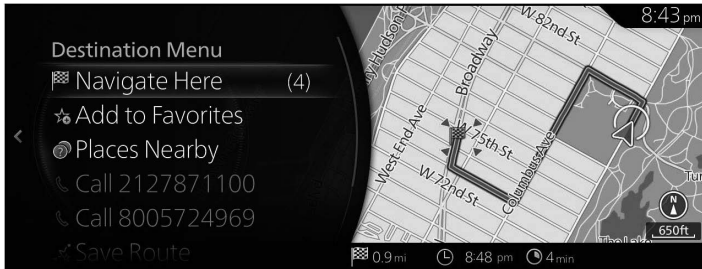

NOTE

- “Places Nearby”: You can search for POI (point of interest) around the selected location.
- “Add to Favorites”: The selected location can be registered to Favorites.

1

2

3

4

5

6

3.1.3 Selecting a map location as the destination

1. Tilt the commander knob to the left or right, or up or down on the current location display screen with the menu closed. The cursor is displayed.

Type A

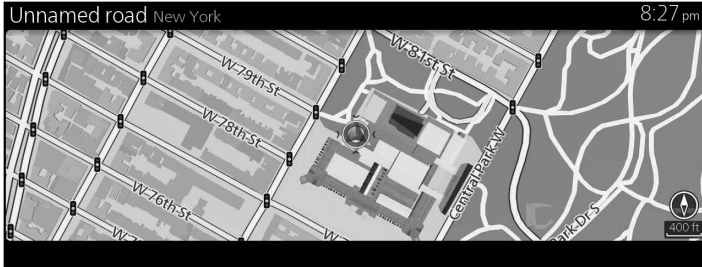

Type B

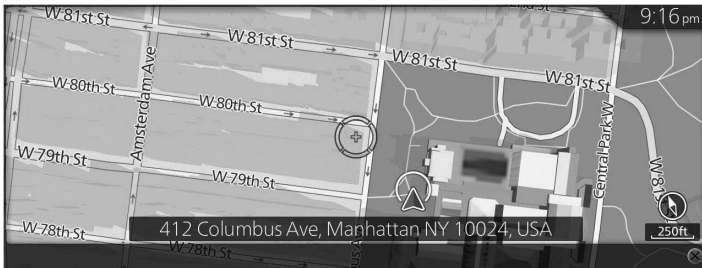

2. Drag the cursor and release it at the desired point.

Type A

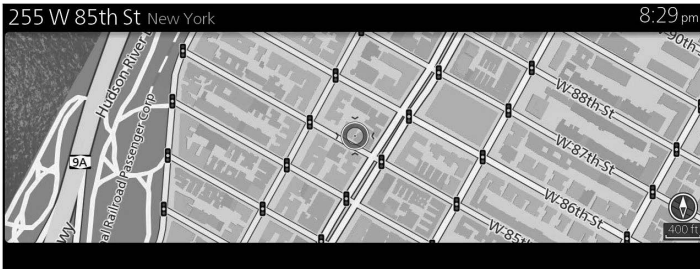

Type B



3. Press the commander knob.

1

2

3

4

5

6

4. The selected location is shown on the map.
The system transitions to the next screen by selecting “Navigate Here”, or it returns to the previous screen by tilting the commander knob to the left. By selecting the location displayed on the screen, you can change the destination to anywhere on the map.

Type A



Type B



NOTE

- “Places Nearby”: You can search for POI (point of interest) around the selected location.
- “Add to Favorites”: The selected location can be registered to Favorites.

5. Navigation starts if “Start Guidance” is selected, or after 10 seconds of no user interaction.
Additionally, the route can be revised by selecting other options.

Type A

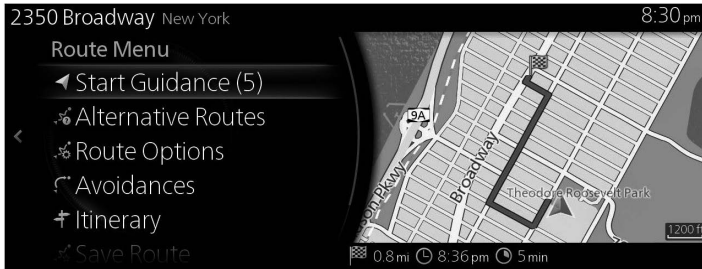

Type B

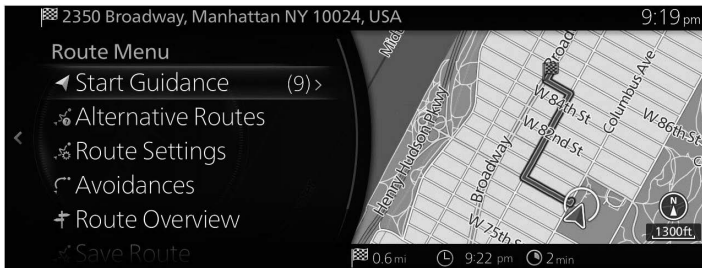

1

2

3

4

5

6

3.1.4 Selecting the destination from your Favorites

Type A

1. Press the commander knob with the map screen open to display the menu, and select "Add Destination".
2. Select "More Favorites".

When "More Favorites" is selected, the screen transfers to the Favorites screen. Select your registered favorite.

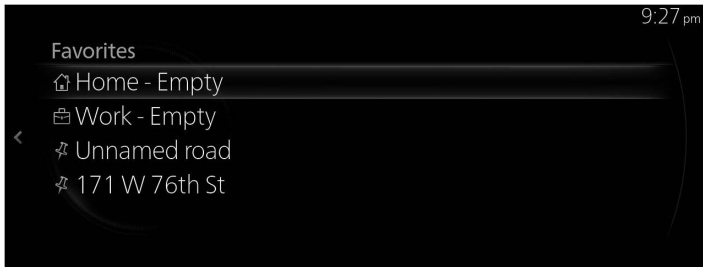
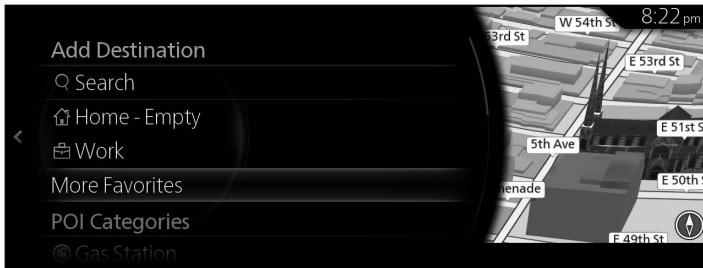

3. Navigation starts if "Start Guidance" is selected, or after 10 seconds of no user interaction.

Additionally, the route can be revised by selecting other options.



Type B

1. Press the commander knob with the map screen open to display the menu, and select "POIs & Favorites".
2. The latest 3 POIs & Favorites are displayed.
If you want to use other Favorites, use the ☆ button. Select your registered Favorites.

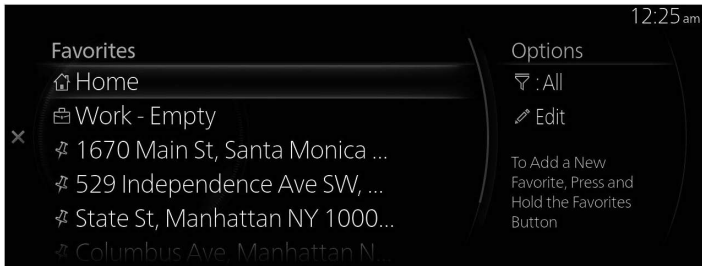
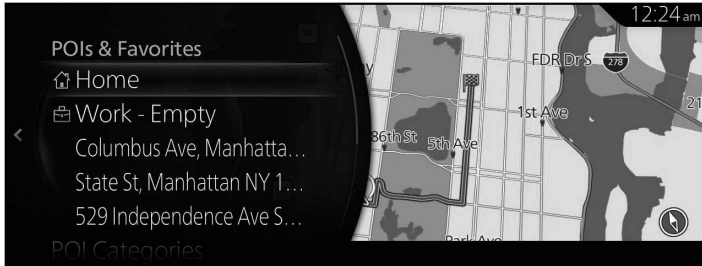

3. Select "Navigate Here" to start the route guidance. In addition, tilt the commander knob to the left to return to the previous screen.
If the user makes no operation for 10 seconds, the navigation starts.

1

2

3

4

5

6

3.1.5 Selecting a recent destination from the History

Type A

1. Press the commander knob with the map screen open to display the menu, and select "Add Destination".
2. Displays a list of recent destinations in "Recent Destinations".

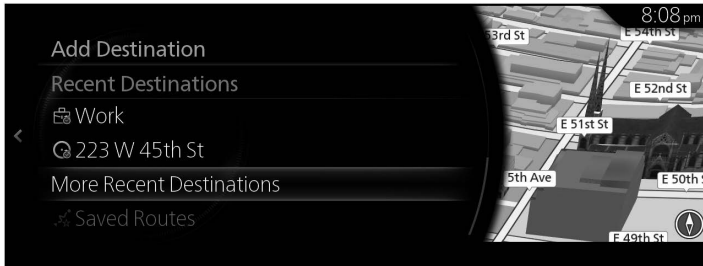

3. Select “More Recent Destinations” to display a list of recently searched destinations. Tilt the commander knob to the right and select “Sort” to rearrange the display order based on “Relevance”, “Time”, “Name”, “Distance”, and “Frequency”.

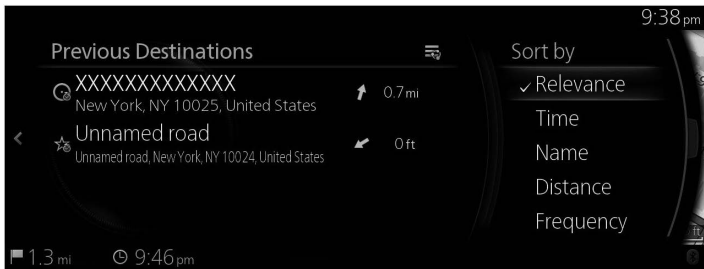
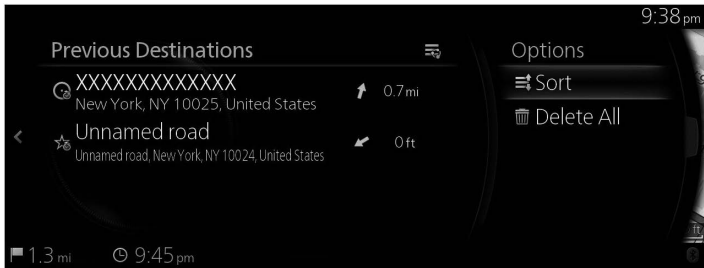
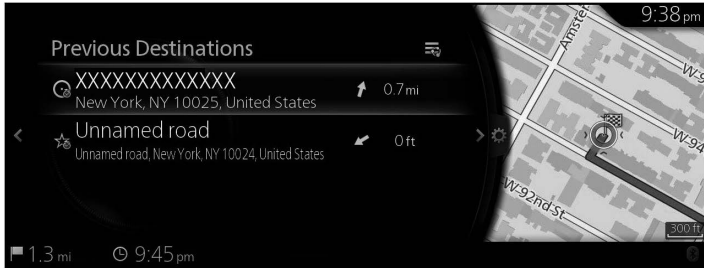

4. Select a destination from the list.

1

2

3

4

5

6

- The selected location is shown on the map. The system transitions to the next screen by selecting “Navigate Here”, or it returns to the previous screen by tilting the commander knob to the left. The destination can be changed to anywhere on the map by tilting the commander knob to the right and using the cursor.



NOTE

- “Places Nearby”: You can search for POI (point of interest) around the selected location.
- “Add to Favorites”: The selected location can be registered to Favorites.

- Navigation starts if “Start Guidance” is selected, or after 10 seconds of no user interaction. Additionally, the route can be revised by selecting other options.

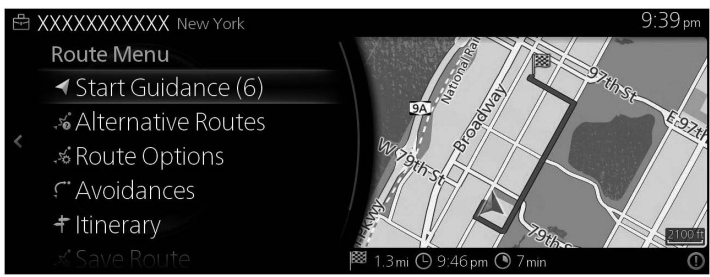

Type B

1. Press the commander knob with the map screen open to display the menu, and select "Recent Destinations".
2. Displays a list of recent destinations in "More".

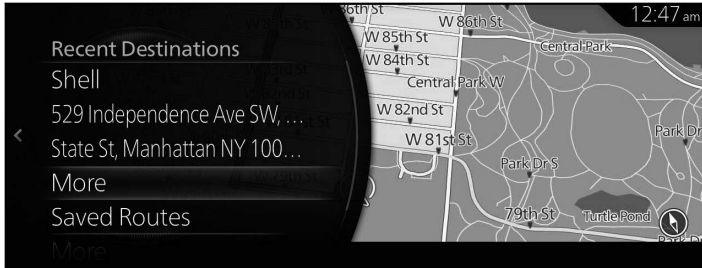

1

2

3

4

5

6

3. Select "More" to display a list of recently searched destinations. Tilt the commander knob to the right and select "Sort" to rearrange the display order based on "Relevance", "Time", "Name", "Distance", and "Frequency".

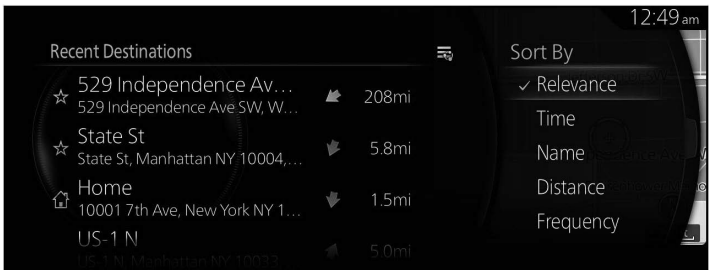
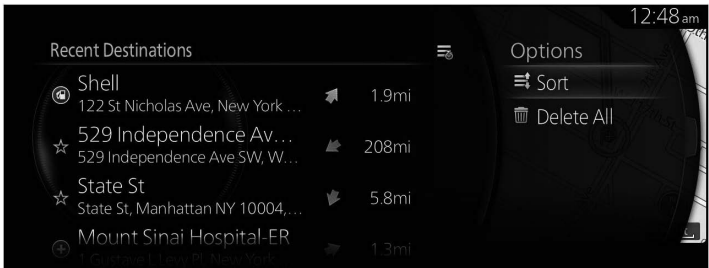
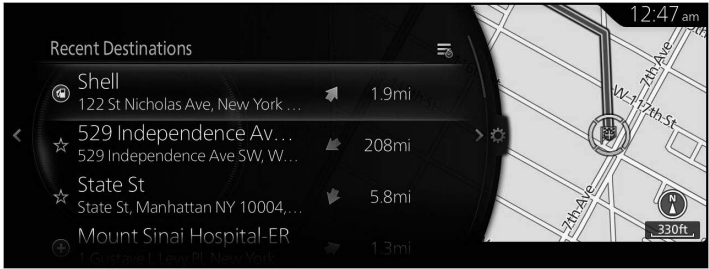

4. Select a destination from the list.

5. The selected location is shown on the map.
The system transitions to the next screen by selecting “Navigate Here”, or it returns to the previous screen by tilting the commander knob to the left.

If the user makes no operation for 10 seconds, the navigation starts.

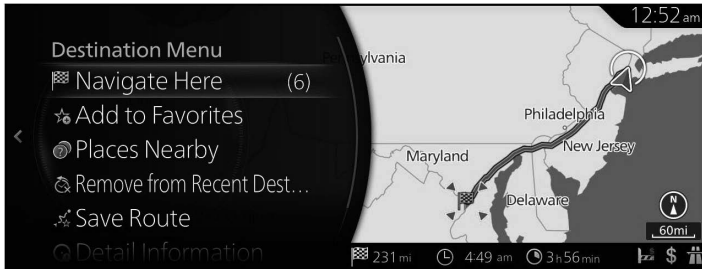

NOTE

- “Places Nearby”: You can search for POI (point of interest) around the selected location.
- “Add to Favorites”: The selected location can be registered to Favorites.

1

2

3

4

5

6

3.1.6 Entering the coordinate of the destination

Type A

You can also select a destination by entering its coordinate as follows:

1. Press the commander knob with the map screen open to display the menu and select "Search" from "Add Destination".
2. Select "Coordinates Entry".



3. Input the latitude and longitude coordinates.



4. When finished, select .

5. The selected location is shown on the map.
The system transitions to the next screen by selecting “Navigate Here”, or it returns to the previous screen by tilting the commander knob to the left. The destination can be changed to anywhere on the map by tilting the commander knob to the right and using the cursor.

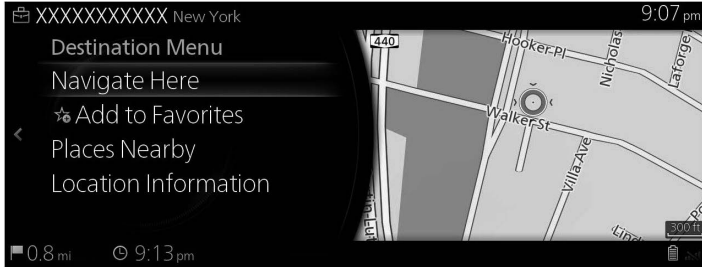

NOTE

- “Places Nearby”: You can search for POI (point of interest) around the selected location.
- “Add to Favorites”: The selected location can be registered to Favorites.

6. Navigation starts if “Start Guidance” is selected, or after 10 seconds of no user interaction.
Additionally, the route can be revised by selecting other options.



Type B

You can also select a destination by entering its coordinate as follows:

1. Press the commander knob with the map screen open to display the menu and select "Where to?".
2. Tilt the commander knob to the right, display the list, and select "Coordinates Entry".



3. Input the latitude and longitude coordinates.

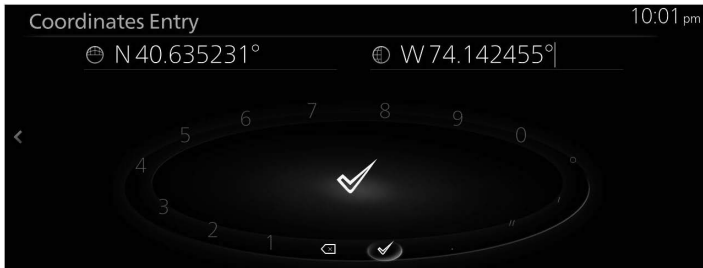

4. When finished, select .

5. The selected location is shown on the map.
The system transitions to the next screen by selecting “Navigate Here”, or it returns to the previous screen by tilting the commander knob to the left.

If the user makes no operation for 10 seconds, the navigation starts.

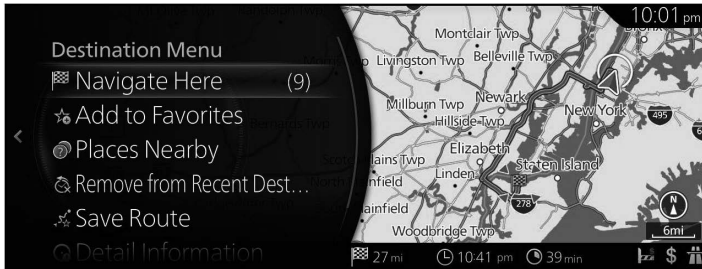

NOTE

- “Places Nearby”: You can search for POI (point of interest) around the selected location.
- “Add to Favorites”: The selected location can be registered to Favorites.

1

2

3

4

5

6

3.1.7 OneBox search

Type A

A destination can be searched using random free words in combination with an address, location name, post number, telephone number, latitude/longitude, road name, or city name.

NOTE

There are some functional limitations to the free word search. (Such as POI (point of interest) + road name is not supported)
It functions when the search results can be set as a destination.

1. Press the commander knob with the map screen open to display the menu and select "Search" from "Add Destination".



2. Input a keyword to be searched and select  to open the search result list.

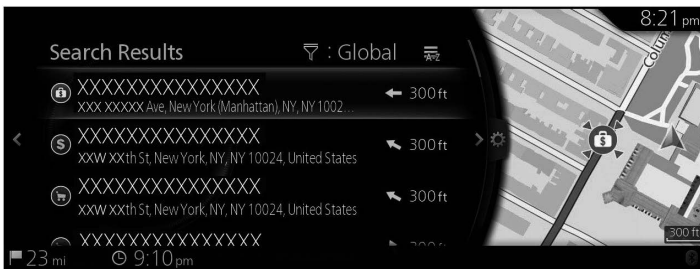

3. Tilt the commander knob to the right and display the option panel to reorder the list from “Sort By” and to limit the area from “Search Area”. (page 39)

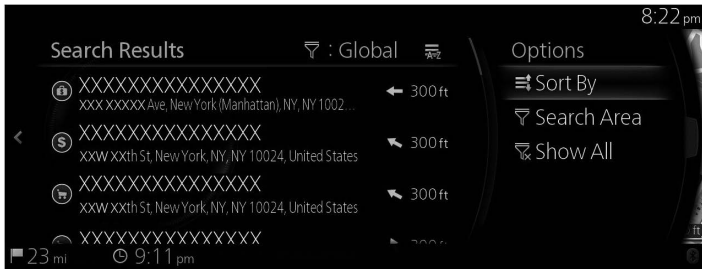

4. The selected location is shown on the map. The system transitions to the next screen by selecting “Navigate Here”, or it returns to the previous screen by tilting the commander knob to the left. The destination can be changed to anywhere on the map by tilting the commander knob to the right and using the cursor.

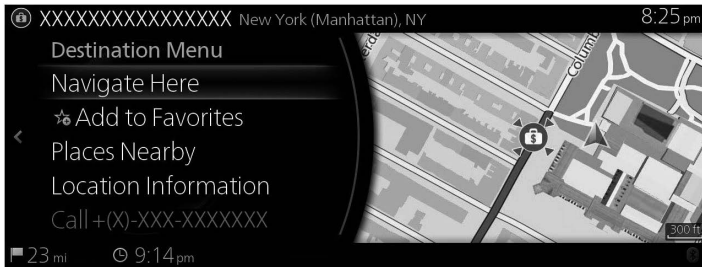

NOTE

- “Places Nearby”: You can search for POI (point of interest) around the selected location.
- “Add to Favorites”: The selected location can be registered to Favorites.



- Navigation starts if "Start Guidance" is selected, or after 10 seconds of no user interaction.
Additionally, the route can be revised by selecting other options.



Type B

A destination can be searched using random free words in combination with an address, location name, post number, telephone number, latitude/longitude, road name, or city name.

NOTE

There are some functional limitations to the OneBox search. (Such as POI (point of interest) + road name is not supported)
It functions when the search results can be set as a destination.

- Press the commander knob with the map screen open to display the menu and select "Where to ?".



2. Input a keyword to be searched and select to open the search result list.

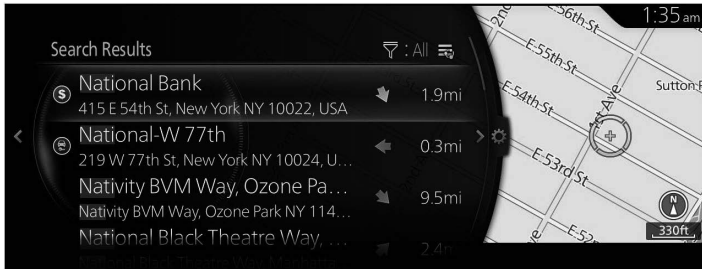

3. Tilt the commander knob to the right and display the option panel to reorder the list from "Sort By" and to limit the area from "Search Area". (page 42)

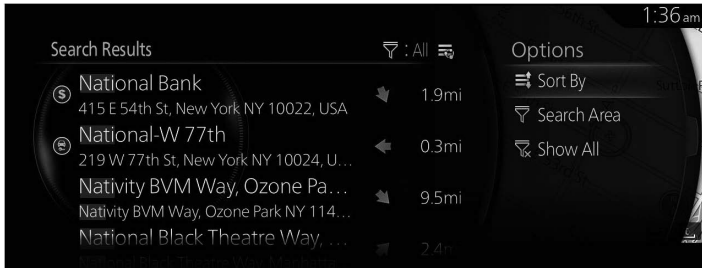

1

2

3

4

5

6

- The selected location is shown on the map.
The system transitions to the next screen by selecting “Navigate Here”, or it returns to the previous screen by tilting the commander knob to the left.
If the user makes no operation for 10 seconds, the navigation starts.

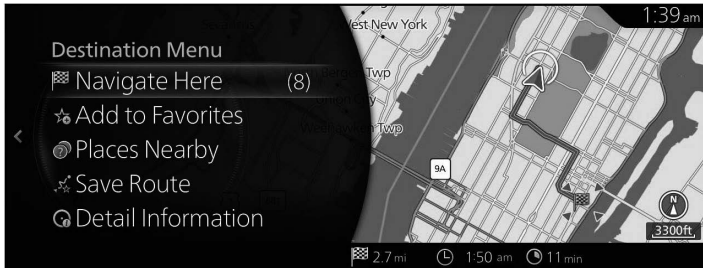

NOTE

- “Places Nearby”: You can search for POI (point of interest) around the selected location.
- “Add to Favorites”: The selected location can be registered to Favorites.

3.2 Checking route parameters and accessing route related functions

You can check different parameters of the route recommended by the navigation system.

1. Press the commander knob with the map screen open to display the menu, and select "Route Options".
2. The following pieces of information are displayed:
 - Type A
The name and/or address of the destination.
 - The total time of the route.
 - The total length of the route.

Type A



Type B

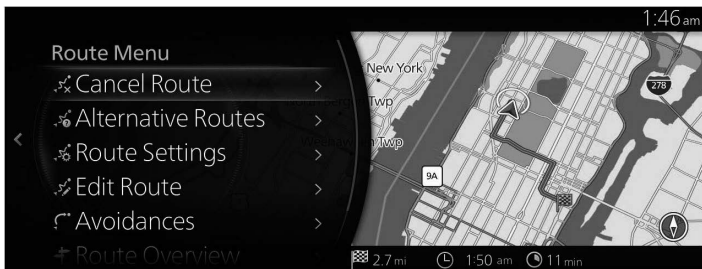

3. You have the following options on this screen (for detailed instructions on how to use them, see the next chapter):
 - Select "Cancel Route" to delete the active route.
 - Select "Alternative Routes" to display available alternative routes.
 - Select "Route Options" to change route calculations.
 - Select "Edit Route" to edit the route.
 - Select "Avoidances" to bypass a part of the route.

- Type A
Select "Itinerary" to display the entire route on the map.
- Type B
Select "Route Overview" to display the entire route on the map.



There are other convenient functions.

3.3 Modifying the route

When navigation is already started, there are several ways to modify the active route. The following sections show some of those options.

3.3.1 Selecting a new destination when already having a route: New Route, Waypoint or Final Destination

If you already have a recommended route and you select a new destination as described in the above sections, the application will ask you whether to start a new route, add a new waypoint (intermediate destination) to the route or append the newly selected destination at the end of the current route.

Type A

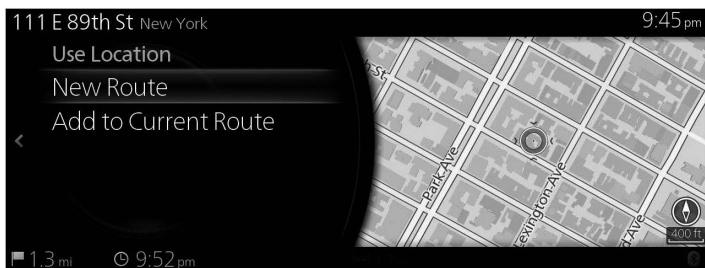

Type B

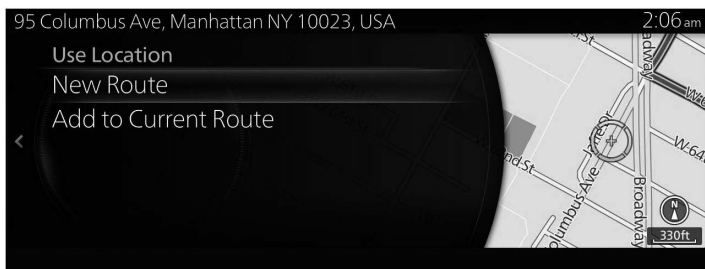

- Select "New Route" to plan a new route to the newly selected location. The previous destination and waypoint(s) are deleted.
- Select "Add to Current Route" to add the newly selected location as an intermediate destination to your route. The other destinations of the route remain intact. Note: the new waypoint is placed among destinations to keep the route optimal. To decide where a waypoint to appear, use the Edit Route feature.

- Select “Add to Current Route” and add the waypoint to the bottom of the displayed list to set a new destination.

Type A

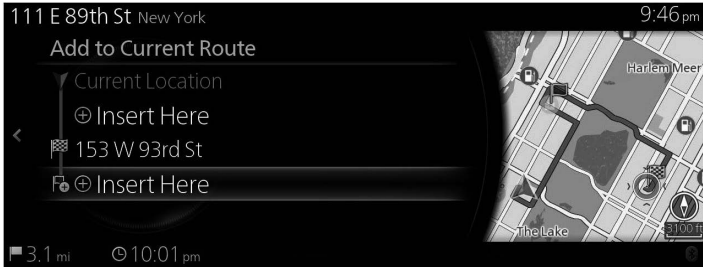

Type B



3.3.2 Editing the list of destinations (Edit Route)

You can edit the route by modifying the list of destinations.

1. Press the commander knob with the map screen open to display the menu, and select "Route Options".
2. Select "Edit Route".

Type A

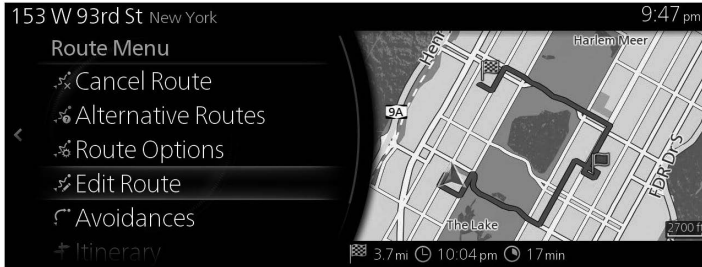

Type B

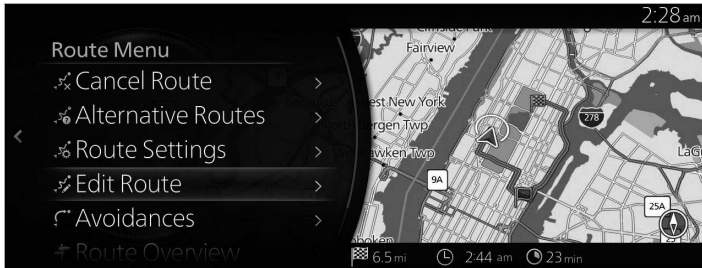

1

2

3

4

5

6

3. Edit the destination or waypoint.
"Add Waypoint": Add the new destination or waypoint.

Type A



Type B

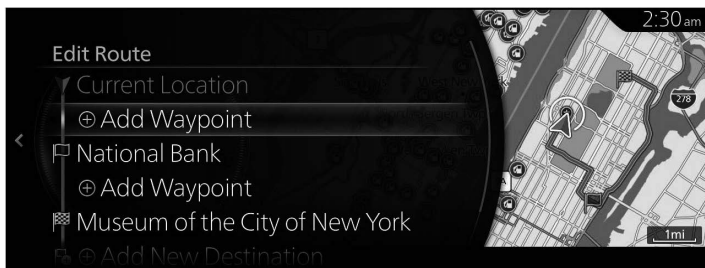

4. Select the destination or waypoint to display the menu.
"Move": Move the selected destination or waypoint up or down one place at a time.
"Replace": Search for a location to replace the selected destination or waypoint.
"Remove": Delete the selected destination or waypoint from the list.

Type A

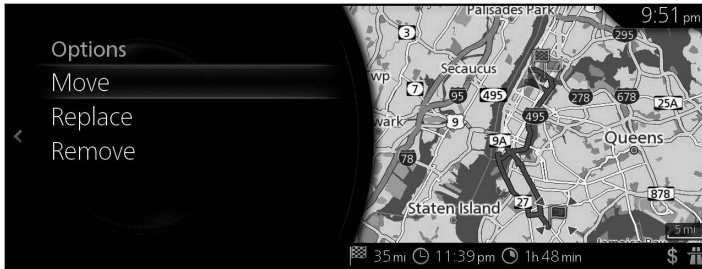

Type B

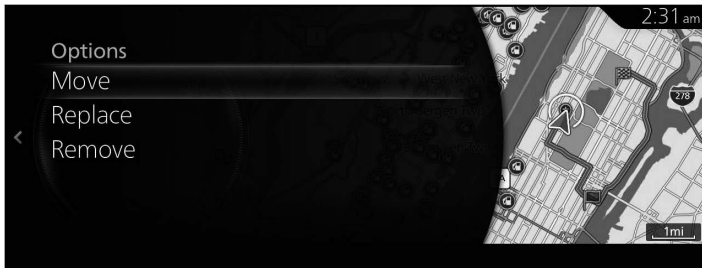

1

2

3

4

5

6

3.3.3 Checking route alternatives when planning the route

You can select from different route alternatives or change the route planning method after you have selected a new destination.

1. Press the commander knob with the map screen open to display the menu, and select "Route Options".

Type A



Type B



2. Select "Alternative Routes".

Type A



Type B

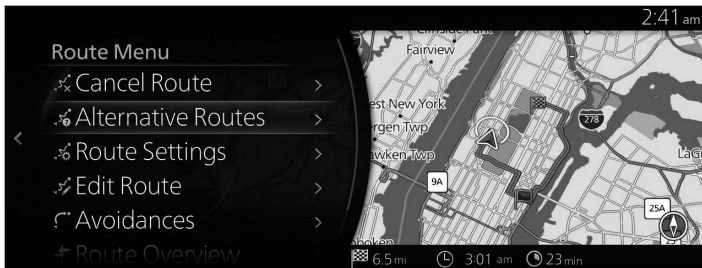

1

2

3

4

5

6

3. The four route alternatives are displayed next to the selected route planning method. Select one to view it on the map.

Type A

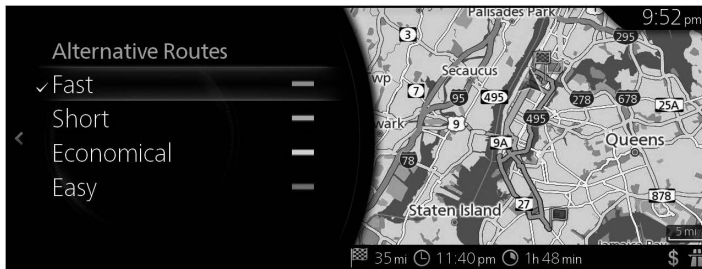

Type B

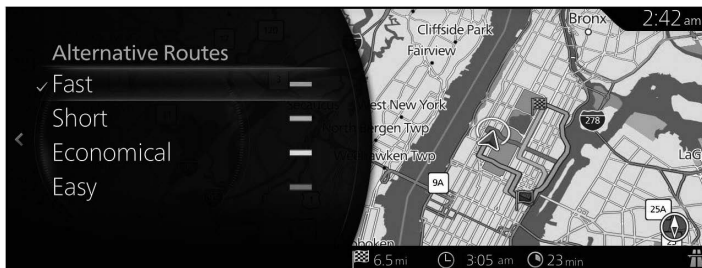

4. The navigation system recalculates the route. The deep blue line now shows the new recommended route.

3.3.4 Changing the road types used in route planning

Type A

To recalculate the active route with different road type preferences, do as follows. These changes can also be made in Settings (page 110).

1. Press the commander knob with the map screen open to display the menu, and select "Navigation Settings".
2. Select "Route Settings".

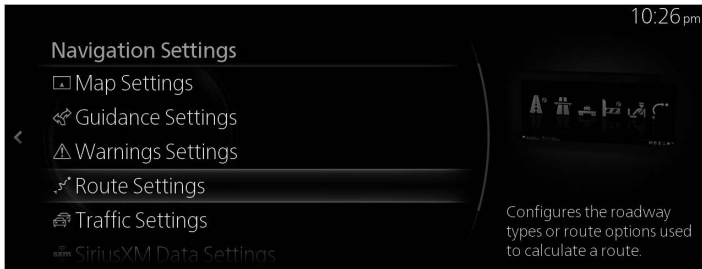

3. Select any of the listed road types to modify the route. If needed, scroll the list for all road types. You have the following options (their order depends on the selected vehicle type):
 - "Allow Highways" - You might need to avoid highways/freeways if you are towing another vehicle.
 - "Allow Toll Roads" - Road segments marked as toll roads in the content (roads for which the user has to pay to drive on) are considered during route calculation.
 - "Allow Border Crossing" - A border crossing may be a shorter route depending on the route. For this function, you can select whether or not to cross a border when planning the route.
 - "Allow Carpool / HOV Lanes" - Setting in which routes with carpool lanes can be created or not created.
 - "Allow Unpaved Roads" - The navigation system excludes unpaved roads by default: unpaved roads can be in a bad condition and usually you cannot reach the speed limit on them.
 - "Allow Ferries" - The navigation system includes ferries in a planned route by default. However, a map does not necessarily contain information about the accessibility of temporary ferries. You might also need to pay a fare on ferries.
 - "Allow Car Shuttle Trains" - Car shuttle train lines considered during route calculation. Car shuttle train lines are usually operated between places not easily accessible on conventional roads.

- “Allow Roads That Need Permits” - Roads and areas that require special permit are considered during route calculation.
 - “Allow Seasonally Restricted Roads” - Roads with seasonal restrictions are considered during route calculation.
4. The route has already been recalculated. Tilt the commander knob to the left to return to the map screen.

 **NOTE**

Some functions are not available depending on some countries and regions.

Type B

To recalculate the active route with different road type preferences, do as follows. These changes can also be made in Settings (page 112).

1. Press the commander knob with the map screen open to display the menu, and select "Navigation Settings".
2. Select "Route Settings".



3. Select any of the listed road types to modify the route. If needed, scroll the list for all road types. You have the following options (their order depends on the selected vehicle type):
 - "Allow Highways" - You might need to avoid highways/freeways if you are towing another vehicle.
 - "Allow Toll Roads" - Permit use on toll roads. If this feature is disabled, the navigation system excludes toll roads and searches for the optimum route.
 - "Allow Border Crossing" - A border crossing may be a shorter route depending on the route. For this function, you can select whether or not to cross a border when planning the route.
 - "Allow Carpool / HOV Lanes" - Setting in which routes with carpool lanes can be created or not created.
 - "Allow Unpaved Roads" - The navigation system excludes unpaved roads by default: unpaved roads can be in a bad condition and usually you cannot reach the speed limit on them.
 - "Allow 4WD Tracks" - If this option is checked special 4WD tracks are considered during route calculation.

- “Allow Ferries” - The navigation system includes ferries in a planned route by default. However, a map does not necessarily contain information about the accessibility of temporary ferries. You might also need to pay a fare on ferries.
 - “Allow Car Shuttle Trains” - Car shuttle train lines considered during route calculation. Car shuttle train lines are usually operated between places not easily accessible on conventional roads.
 - “Allow Roads That Need Permits” - Roads and areas that require special permit are considered during route calculation.
 - “Allow Seasonally Restricted Roads” - Roads with seasonal restrictions are considered during route calculation.
4. The route has already been recalculated. Tilt the commander knob to the left to return to the map screen.

 NOTE

Some functions are not available depending on some countries and regions.

3.4 Saving a location as a Favorite destination

You can add any location to Favorites, the list of frequently used destinations. Planning a route to one of the Favorite destinations is described on page 64.

1. Select a destination as described before. It can be an address, a Place, any location on the map, a previously used destination from History, etc.
2. A searched destination can be registered to Favorites by selecting “Add to Favorites” on the verification screen of the destination search results.

Type A



Type B



3.4.1 Editing the details of a Favorite destination

You can select a location that you have already saved as a Favorite and edit its details. Adding a location to the list of Favorite destinations is described on page 95.

1. Press the Favorites button on the commander switch.
2. Go to Options and Select the Navigation tab from the list "All".
3. The list of Favorite destinations is displayed.

Type A

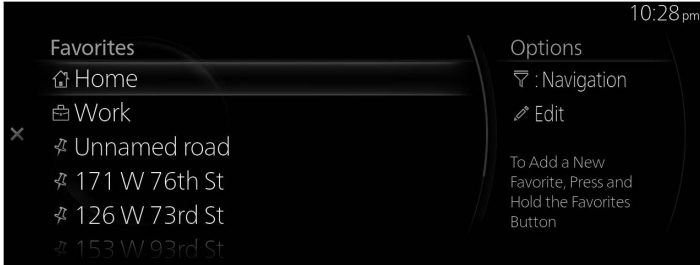

Type B

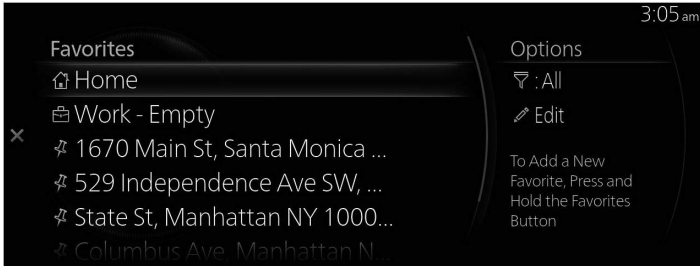

The following functions can be used by selecting Edit Navigation Favorite.

Reorder Favorites.

Rename Favorites.

Edit Home → Change Home location

Edit Work → Change Work location

Delete Favorite(s)

4 Reference Guide

4.1 Concepts

4.1.1 Smart Zoom

Smart Zoom provides much more than just a usual automatic zoom feature:

- **While following a route:** when approaching a turn, it will zoom in and raise the view angle to let you easily recognize your maneuver at the next junction. If the next turn is at a distance, it will zoom out and lower the view angle to be flat so you can see the road in front of you.
- **While driving without an active route:** Smart Zoom will zoom in if you drive slowly and zoom out when you drive at high speed.
- **Automatic Zoom Setting Off:** Turns the Smart Zoom off.

4.1.2 Route calculation and recalculation

The navigation system calculates the route based on your preferences:

- Route planning methods:
 - “Fast” : Gives a quick route if you can travel at or near the speed limit on all roads.
 - “Short” : Gives a route that has the smallest total distance of all possible routes.
 - “Economical” : This method combines the merits of the Fast and Short routes: The navigation system makes a calculation for the Fast route, but it also includes other roads in the calculation in consideration of fuel economy.
 - “Easy” : Results in a route with fewer turns and no difficult maneuvers. With this option, you can make the navigation system take, for example, the highway/freeway instead of a series of smaller roads or streets.

1

2

3

4

5

6

- Road type used for route plan:
 - Type A
 - Allow Highways
 - Allow Toll Roads
 - Allow Border Crossing
 - Allow Carpool / HOV Lanes
 - Allow Unpaved Roads
 - Allow Ferries
 - Allow Car Shuttle Trains
 - Allow Roads That Need Permits
 - Allow Seasonally Restricted Roads
 - Type B
 - Allow Highways
 - Allow Toll Roads
 - Allow Border Crossing
 - Allow Carpool / HOV Lanes
 - Allow Unpaved Roads
 - Allow 4WD Tracks
 - Allow Ferries
 - Allow Car Shuttle Trains
 - Allow Roads That Need Permits
 - Allow Seasonally Restricted Roads

If data exists and the setting is valid, route calculation takes into account historical traffic data for the given day of week and time of day (page 101).

If the setting for Traffic Settings is valid, Real-time Traffic events are taken into account and the route is largely modified.

The navigation system automatically recalculates the route if you deviate from the proposed itinerary or if a newly received Traffic event concerns a part of the recommended route.

For further information about Route Settings, see page 110.



Some functions are not available depending on some countries and regions.

4.1.3 Speed limit warning (Only some countries and regions)

Maps may contain information about the speed limits of the roads. The navigation system is able to warn you if you exceed the current limit. This information may not be available for your region (ask your local dealer), or may not be fully correct for all roads on the map.

*The speed limit warning operates only on vehicles that display the following settings.

Except vehicles with Active Driving Display

The speed warning can be set from the Warnings Settings (page 107).

Setting can be selected using "Warnings Settings" → "Speeding":

- Audio and Visuals warning: You will hear a warning beep with visuals if you exceed the speed limit by a certain percentage.
- Visual Alerts: If you exceed the speed limit on a road, the speed limit for the current road is shown on the map or on the active driving display. You can also choose to see the speed limit sign on the map all the time.

Vehicles with Active Driving Display

1. Select the "Settings" on the home screen to display the Settings screen.
2. Select the "Active Driving Display" menu.
3. Select the "Speed Limit Alert" on the screen to select the item you would like to change.

1

2

3

4

5

6

4.1.4 Traffic information in route planning (Only some countries and regions)

Type A

The recommended route is not always the same between two points. Offline historical traffic information (historical speed information or traffic patterns) can be taken into account in the route calculation based on the time of day and the day of week whenever suitable data exists.

It is necessary to set the following to display traffic information on the map.

1. Press the commander knob with the map screen open to display the menu, and select "Traffic Settings" from "Navigation Settings".
2. Set either "Flow and Icons", "Flows Only", or "Icons Only" in "Show Traffic Information".
3. Return to "Navigation Settings" and select "SiriusXM Data Settings" to turn it on.

A 2D map is displayed with road segments colored by the density of the traffic in the given period. The current information is shown when you open the screen. Modify the day of week and the time of day to see the desired period.

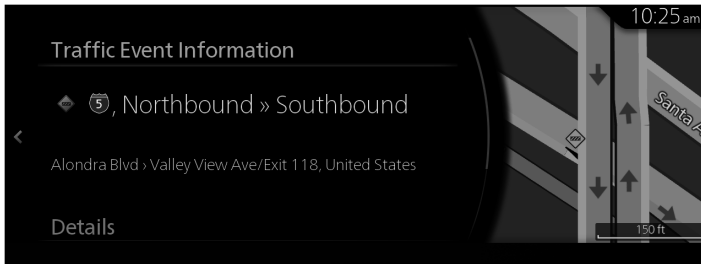

Type B

The recommended route is not always the same between two points. Offline historical traffic information (historical speed information or traffic patterns) can be taken into account in the route calculation based on the time of day and the day of week whenever suitable data exists. In addition, real-time traffic information can help you avoid current traffic events like temporary road closures or a traffic jam caused by an accident. Both functions are subject to data availability.

It is necessary to set the following to display traffic information on the map.

1. Press the commander knob with the map screen open to display the menu, and select "Traffic Settings" from "Navigation Settings".
2. Set either "Flow and Icons", "Flows Only", or "Icons Only" in "Show Traffic Information".
3. Return to "Navigation Settings" and select "SiriusXM Data Settings" to turn it on.

A 2D map is displayed with road segments colored by the density of the traffic in the given period. The current information is shown when you open the screen. Modify the day of week and the time of day to see the desired period.

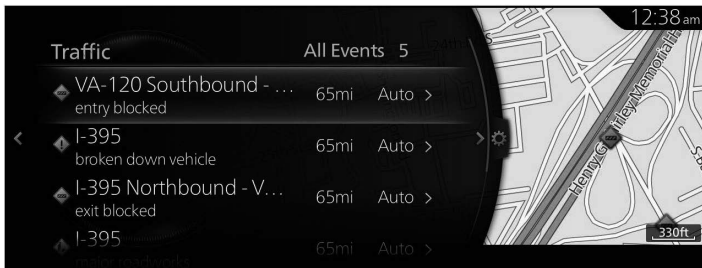

4.1.4.1 Historical traffic

If historical traffic information is available with the map data, the navigation system can use it when planning a route. In normal cases, these statistics help you avoid usual traffic jams on the given day of week in the given hour but in some cases like on public holidays that fall on normal weekdays, they can be misleading. You can disable this feature in Traffic Settings (page 108).

4.1.5 SiriusXM Travel Link* (Only some models)

SiriusXM Travel Link provides useful information for driving such as traffic data and weather forecasts using the data from satellite radio.

NOTE

This service is fee-based. A separate subscription is required to obtain this service.

Refer to the user instructions for details.

4.1.5.1 Traffic Plus

Traffic Plus is a service providing users the latest traffic information. You can check a map for roads where traffic jams are occurring and receive traffic information such as areas under construction or traffic lane closures.

1. Press the commander knob with the map screen open to display the menu and select "SiriusXM Travel Link" from "Travel Information".
2. Select "Traffic Plus".

3. **(When checking for details on traffic information)**

Select "Show All Events". Select the desired item following the displayed list to display the details on traffic information.

Type A

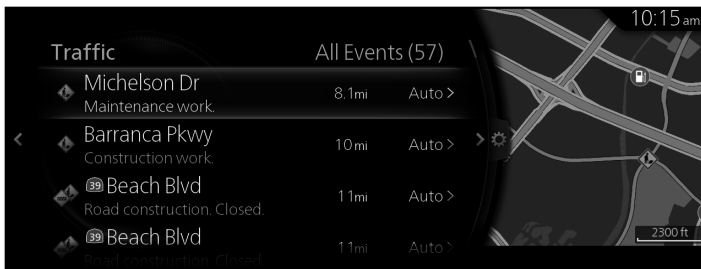

Type B

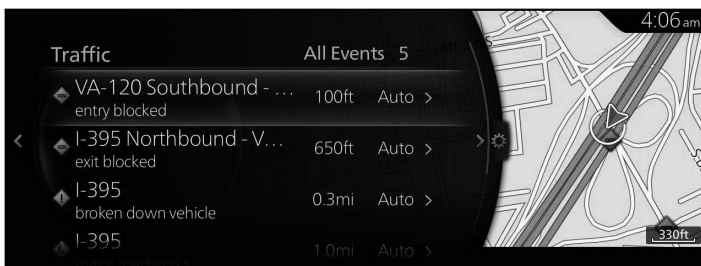

NOTE

You can select settings for detour route searches when traffic information is received by selecting “Traffic Settings (Type A)/Traffic (Type B)” in Step 3.

Type A

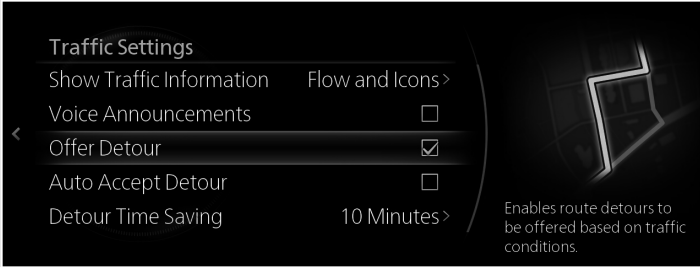

Type B

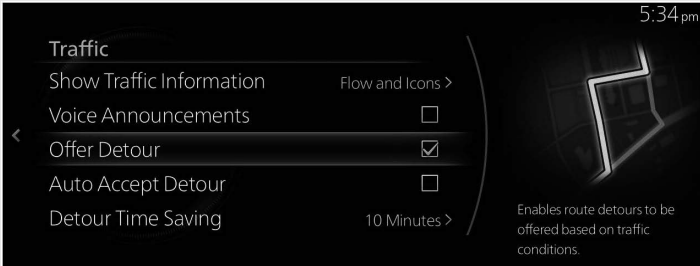

1

2

3

4

5

6

4.1.5.2 Weather Radar

You can check weather forecasts using the Weather Radar service. Weather radar, pressure pattern, and hurricane/tropical storm information can be displayed on the map screen.

1. Press the commander knob with the map screen open to display the menu and select "SiriusXM Travel Link" from "Travel Information".
2. Select "Weather Radar".

Type A

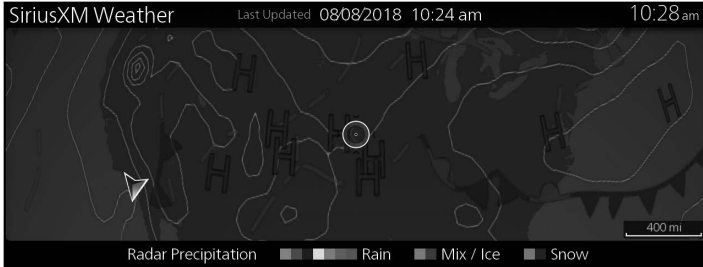

Type B

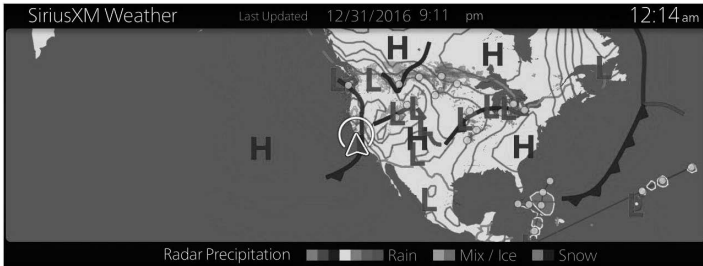

4.2 Settings menu

You can configure the program settings, and modify the behavior of the navigation system. Press the commander knob with the map screen open to display the menu, and select “Navigation Settings”.

Type A

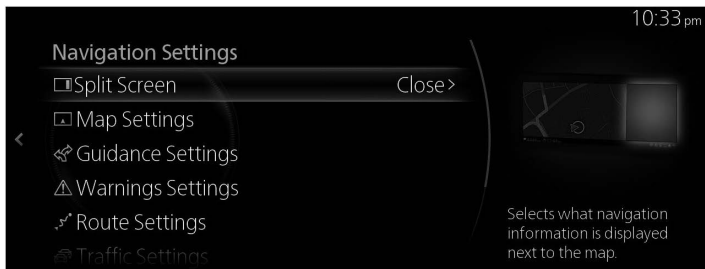

Type B

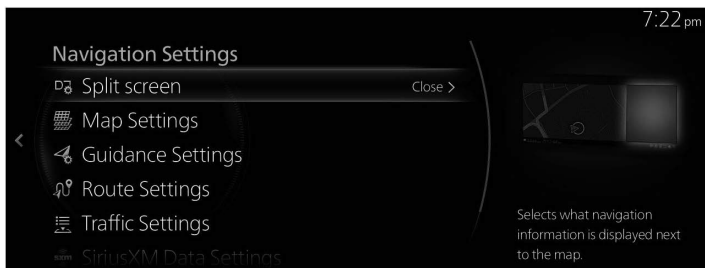

Setting Item	Description
Split Screen	You can select navigation information displayed on the side panel.
Map Settings	You can fine-tune the appearance of the Map screen. Adjust the map view to your needs, show or hide 3D buildings, and manage POI (point of interest) display settings (which POI to show on map).
Guidance Settings	A guidance-related setting is available during route guidance.
Warnings Settings	A setting related to warnings is available.

Setting Item	Description
Route Settings	Refer to Changing the road types used in route planning (page 91).
Traffic Settings	A setting for traffic information is available.
SiriusXM Data Settings	A setting for SiriusXM (SiriusXM Travel Link) service is available.



Some functions are not available depending on some countries and regions.

4.2.1 Guidance Settings

Setting Item	Description
Guidance Volume 	The guidance audio volume can be changed during route guidance.

4.2.2 Warnings Settings

Warning and alert settings are available.

Setting Item	Description
Speed Limit *Except vehicles with Active Driving Display	The speed limit warning display can be changed. "Always": Constantly displayed "When speeding": Displays only when vehicle speed exceeds speed limit
Speeding *Except vehicles with Active Driving Display	The following alert types are available: "Visual Alerts": Only display "Audio and Visual": Both sound and display "None": No display and sound *If the guidance volume is set to 0, the speed limit notification is also 0 because it is part of the guidance.

NOTE

Some functions are not available depending on some countries and regions.

1

2

3

4

5

6

4.2.3 Traffic Settings

Type A

Setting Item	Description
Use Historical Traffic Data	Use this switch to enable or disable historical traffic data and traffic patterns. This locally stored information can be very useful in normal circumstances but for example on public holidays it may be better to turn off in order not to take into account normal weekday traffic jams.
Show Traffic Information	You can change how the traffic information is displayed. "Flow and Icons": Displays traffic information by color coding the traffic icons and traffic flow. "Flows Only": Displays traffic information by traffic flow colors only. "Icons Only": Displays traffic information by traffic icons only. "Off": Disables display of traffic information.
Voice Announcements	Enables/disables traffic announcements using voice.
Offer Detour	Alternative routes are offered for detours.
Auto Accept Detour	An appropriate alternative route is determined provided by the navigation system in consideration of traffic conditions.
Detour Time Saving	You can select how much time delay on the alternative route you are willing to accept. The alternative route is offered based on the set time.



Some functions are not available depending on some countries and regions.

Type B

Setting Item	Description
Show Traffic Information	You can change how the traffic information is displayed. "Traffic Flow & Icons": Displays traffic information by color coding the traffic icons and traffic flow. "Traffic Flow": Displays traffic information by traffic flow colors only. "Traffic Icon": Displays traffic information by traffic icons only. "Off": Disables display of traffic information.
Voice Announcements	Enables/disables traffic announcements using voice.
Offer Detour	Alternative routes are offered for detours.
Auto Accept Detour	An appropriate alternative route is determined provided by the navigation system in consideration of traffic conditions.
Detour Time Saving	You can select how much time delay on the alternative route you are willing to accept. The alternative route is offered based on the set time.

NOTE

Some functions are not available depending on some countries and regions.

1

2

3

4

5

6

4.2.4 Route Settings

These settings determine how routes will be calculated.

Type A

Setting Item	Description
Route Calculation Method	The route calculation can be optimized for different situations. See below for details.
Allow Highways	You might need to avoid highways/freeways if you are towing another vehicle.
Allow Toll Roads	Road segments marked as toll roads in the content (roads for which the user has to pay to drive on) are considered during route calculation.
Allow Border Crossing	A border crossing may be a shorter route depending on the route. For this function, you can select whether or not to cross a border when planning the route.
Allow Carpool / HOV Lanes	Setting in which routes with carpool lanes can be created or not created.
Allow Unpaved Roads	The navigation system excludes unpaved roads by default: unpaved roads can be in a bad condition and usually you cannot reach the speed limit on them.
Allow Ferries	The navigation system includes ferries in a planned route by default. However, a map does not necessarily contain information about the accessibility of temporary ferries. You might also need to pay a fare on ferries.
Allow Car Shuttle Trains	Car shuttle train lines considered during route calculation. Car shuttle train lines are usually operated between places not easily accessible on conventional roads.

Setting Item	Description
Allow Roads That Need Permits	Roads and areas that require special permit are considered during route calculation.
Allow Seasonally Restricted Roads	Roads with seasonal restrictions are considered during route calculation.

 **NOTE**

Some functions are not available depending on some countries and regions.

1

2

3

4

5

6

Type B

Setting Item	Description
Route Calculation Method	The route calculation can be optimized for different situations. See below for details.
Allow Highways	You might need to avoid highways/freeways if you are towing another vehicle.
Allow Toll Roads	The use of toll roads is enabled/disabled. If this feature is disabled, the navigation system excludes toll roads and searches for the optimum route.
Allow Border Crossing	A border crossing may be a shorter route depending on the route. For this function, you can select whether or not to cross a border when planning the route.
Allow Carpool / HOV Lanes	Setting in which routes with carpool lanes can be created or not created.
Allow Unpaved Roads	The navigation system excludes unpaved roads by default: unpaved roads can be in a bad condition and usually you cannot reach the speed limit on them.
Allow 4WD Tracks	If this option is checked special 4WD tracks are considered during route calculation.
Allow Ferries	The navigation system includes ferries in a planned route by default. However, a map does not necessarily contain information about the accessibility of temporary ferries. You might also need to pay a fare on ferries.
Allow Car Shuttle Trains	Car shuttle train lines considered during route calculation. Car shuttle train lines are usually operated between places not easily accessible on conventional roads.
Allow Roads That Need Permits	Roads and areas that require special permit are considered during route calculation.

Setting Item	Description
Allow Seasonally Restricted Roads	Roads with seasonal restrictions are considered during route calculation.

NOTE

Some functions are not available depending on some countries and regions.

1

2

3

4

5

6

4.2.5 Map Settings

You can fine-tune the appearance of the Map screen, adjust the map view to your needs, show or suppress 3D buildings, and manage Place visibility settings (which Places to show on the map).

Type A

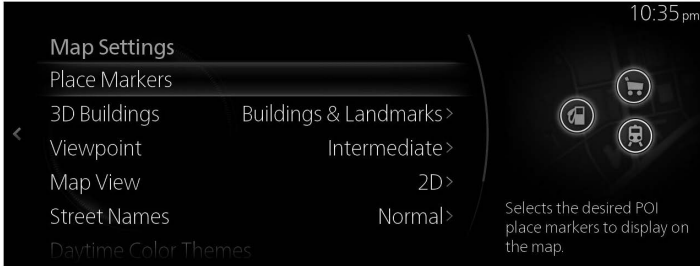

Type B

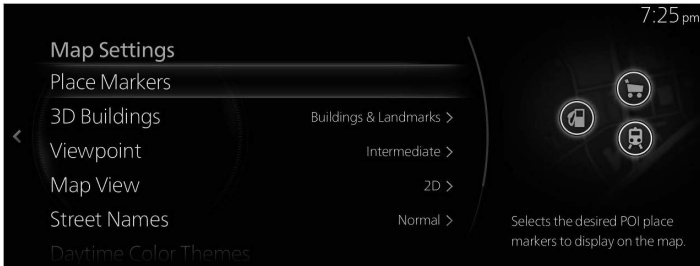

Setting Item	Description
Place Markers	Select which Places to show on the map while navigating. Too many Places make the map crowded, so it is a good idea to show as few as possible. You have the following possibilities: <ul style="list-style-type: none"> • Select the checkbox to show or hide the Place category. • Select the name of the Place category to open the list of its subcategories.
3D Buildings	Shows or hides 3D city models, 3D artistic or block representation of all city building data containing actual building sizes and positions on the map.

Setting Item	Description
Viewpoint	Adjust the basic zoom and tilt levels to your needs. Three levels are available.
Map View	<p>When this item is selected, the map view mode can be changed.</p> <ul style="list-style-type: none"> • “3D”: Displays things such as actual construction sites three dimensionally on the map. • “2D”: The map is rotated so that the direction of travel is displayed in the upward direction. • “2D N”: The map is displayed so that north is up regardless of the direction of travel.
Street Names	Changes the font size of the displayed street names.
Daytime Color Themes	Selects between 5 different color themes for the map displayed during the daytime.
Nighttime Color Themes	Selects between 5 different color themes for the map displayed during the nighttime.

- 1
- 2
- 3
- 4
- 5
- 6

4.2.6 Visual Guidance settings

Adjust how the software helps you navigate with different kinds of route related information on the Map screen.

Setting Item	Description
Automatic Zoom	During route guidance in any map view mode, the function for zooming in on approaching intersections turns on/off automatically.
Highway Overview	When enabled, the map zooms out to show an overview of the surrounding area if the next route event (maneuver) is far away. The system goes back to the normal map view when you approach the next event.
Highway Exit Information	Enables/disables the display of information concerning available highway services in the side panel.
Signposts	Whenever adequate information is available, lane information similar to the real ones on road signs above the road is displayed at the top of the map. You can turn this feature on or off.
Junction View	If you are approaching a highway/freeway exit or a complex intersection and the needed information exists, the map is replaced with a 3D view of the junction. You can turn this feature on or let the map be displayed for the whole route.
Tunnel View	When entering tunnels, the surface roads and buildings can be disturbing. This feature shows a generic picture of a tunnel instead of the map. A top-down overview of the tunnel and remaining distance are also displayed.
Maneuver List Order	Sets the maneuver list order in the side panel.

5 Glossary

Active route

The currently navigated route. Whenever a destination is set, the route is active until you delete it or reach your destination. See also: Route.

City Center

The city center is not the geometric center of the city but an arbitrary point the map creators have chosen. In cities and villages, it is usually the most important intersection; in larger cities, it is one of the important intersections.

Color theme

The navigation system has different color themes for daytime and nighttime which can be selected as desired.

One daytime scheme and one nighttime scheme is always selected for the map and for the menus.

The navigation system uses them when it switches from day to night and back.

GNSS (GPS+GLONASS) accuracy

Several factors have impact on the deviation between your real position and the one given by the GNSS (GPS+GLONASS) device. For example, signal delay in the ionosphere or reflecting objects near the GNSS (GPS+GLONASS) device have a different and varying impact on how accurately the GNSS (GPS+GLONASS) device can calculate your position.

1

2

3

4

5

6

Map

The navigation system works with digital maps which are not simply the computerized versions of traditional paper maps. Similarly to paper road maps, the 2D mode of digital maps show you streets, roads, and elevation by colors.

In 3D mode, you can see the altitude differences, for example valleys and mountains, elevated roads, and in selected cities 3D landmarks and 3D buildings are also displayed.

You can use digital maps interactively: you can zoom in and out (increase or decrease the scale), you can tilt them up and down, and rotate them left and right. In GNSS (GPS+GLONASS)-supported navigation, digital maps facilitate route planning.

North-up map orientation

In North-up mode the map is rotated so its top always faces North.

Road Safety Camera

This function is not available in some countries and regions.

Special alert points for speed, red light or bus lane cameras. Different data sources are available. You can configure the navigation system to warn you when you approach one of these cameras.

Detecting the location of Road Safety Cameras is prohibited in certain countries. It is the sole responsibility of the driver to check whether this feature can be used during the trip.

The software is capable of showing and warning for more than just cameras.

Type A

Various other types of proximity alert points like school zones and railway crossings are also available.

Type B

The other types of proximity alert points like school zones.

Route

A sequence of maneuvers (for example, turns and roundabouts) to reach the destination. The route contains one start point and one or more destinations.

Track-up map orientation

In Track-up mode the map is rotated so its top always points in the current driving direction. This is the default orientation in 3D map view mode.

Vehicle marker

The current position is indicated by a blue arrow on the map. The direction the blue arrow is pointed indicates the current heading.

6 End-User Terms

The data is provided for your personal, internal use only and not for resale. It is protected by copyright and is subject to the following terms and conditions which are agreed to by you, on the one hand, and Panasonic Corporation and its licensors (including their licensors and suppliers) on the other hand.

© 2018 HERE. All rights reserved.

Limitations on Use

The Data includes certain information and related content provided under license from third parties and is subject to the applicable supplier terms and copyright notices set forth at the following URL:

<https://legal.here.com/en-gb/terms/general-content-supplier-terms-and-notices>

Terms and Conditions

Personal Use Only: You agree to use this Data together with Panasonic's CMU for the solely personal, non-commercial purposes for which you were licensed, and not for service bureau, time-sharing or other similar purposes. Accordingly, but subject to the restrictions set forth in the following paragraphs, you agree not to otherwise reproduce, copy, modify, decompile, disassemble or reverse engineer any portion of this Data, and may not transfer or distribute it in any form, for any purpose, except to the extent permitted by mandatory laws.

Warning: The Data may contain inaccurate or incomplete information due to the passage of time, changing circumstances, sources used and the nature of collecting comprehensive geographic data, any of which may lead to incorrect results.

No Warranty: This Data is provided to you "as is," and you agree to use it at your own risk. Panasonic Corporation and its licensors (and their licensors and suppliers) make no guarantees, representations or warranties of any kind, express or implied, arising by law or otherwise, including but not limited to, content, quality, accuracy, completeness, effectiveness, reliability, fitness for a particular purpose, usefulness, use or results to be obtained from this Data, or that the Data or server will be uninterrupted or error-free.

1

2

3

4

5

6

Disclaimer of Warranty: Panasonic Corporation AND ITS LICENSORS (INCLUDING THEIR LICENSORS AND SUPPLIERS) DISCLAIM ANY WARRANTIES, EXPRESS OR IMPLIED, OF QUALITY, PERFORMANCE, MERCHANTABILITY, FITNESS FOR A PARTICULAR PURPOSE OR NON-INFRINGEMENT. Some States, Territories and Countries do not allow certain warranty exclusions, so to that extent the above exclusion may not apply to you.

Disclaimer of Liability: Panasonic Corporation AND ITS LICENSORS (INCLUDING THEIR LICENSORS AND SUPPLIERS) SHALL NOT BE LIABLE TO YOU: IN RESPECT OF ANY CLAIM, DEMAND OR ACTION, IRRESPECTIVE OF THE NATURE OF THE CAUSE OF THE CLAIM, DEMAND OR ACTION ALLEGING ANY LOSS, INJURY OR DAMAGES, DIRECT OR INDIRECT, WHICH MAY RESULT FROM THE USE OR POSSESSION OF THE INFORMATION; OR FOR ANY LOSS OF PROFIT, REVENUE, CONTRACTS OR SAVINGS, OR ANY OTHER DIRECT, INDIRECT, INCIDENTAL, SPECIAL OR CONSEQUENTIAL DAMAGES ARISING OUT OF YOUR USE OF OR INABILITY TO USE THIS INFORMATION, ANY DEFECT IN THE INFORMATION, OR THE BREACH OF THESE TERMS OR CONDITIONS, WHETHER IN AN ACTION IN CONTRACT OR TORT OR BASED ON A WARRANTY, EVEN IF HERE OR ITS LICENSORS HAVE BEEN ADVISED OF THE POSSIBILITY OF SUCH DAMAGES. Some States, Territories and Countries do not allow certain liability exclusions or damages limitations, so to that extent the above may not apply to you.

Export Control. You shall not export from anywhere any part of the Data or any direct product thereof except in compliance with, and with all licenses and approvals required under, applicable export laws, rules and regulations, including but not limited to the laws, rules and regulations administered by the Office of Foreign Assets Control of the U.S. Department of Commerce and the Bureau of Industry and Security of the U.S. Department of Commerce.

Entire Agreement. These terms and conditions constitute the entire agreement between Panasonic Corporation (and its licensors, including their licensors and suppliers) and you pertaining to the subject matter hereof, and supersedes in their entirety any and all written or oral agreements previously existing between us with respect to such subject matter. This agreement is without prejudice to your agreement with the Application provider.

Governing Law. The above terms and conditions shall be governed by the laws of the State of Illinois, U.S.A., except if you are located in Europe, Middle East, Africa or Russia in which case the laws of The Netherlands shall apply, in each case without giving effect to (i) the conflict of laws provisions, or (ii) the United Nations Convention for Contracts for the International Sale of Goods, which are explicitly excluded. You agree to submit to the jurisdiction of the State of Illinois, U.S.A., except if Dutch law applies the jurisdiction of The Netherlands shall apply, for any and all disputes, claims and actions arising from or in connection with the Data provided to you hereunder.

Government End Users. If the Data is being acquired by or on behalf of the United States government or any other entity seeking or applying rights similar to those customarily claimed by the United States government, the Data is a “commercial item” as that term is defined at 48 C.F.R. (“FAR”) 2.101, is licensed in accordance with these End-User Terms, and each copy of Data delivered or otherwise furnished shall be marked and embedded as appropriate with the following “Notice of Use,” and shall be treated in accordance with such Notice:

NOTICE OF USE

CONTRACTOR (MANUFACTURER/ SUPPLIER) NAME: HERE
CONTRACTOR (MANUFACTURER/SUPPLIER) ADDRESS: 425 W. Randolph Street, Chicago, Illinois 60606

This Data is a commercial item as defined in FAR 2.101 and is subject to these End-User Terms under which this Data was provided.

© 1987 - 2018 HERE – All rights reserved.

If the Contracting Officer, federal government agency, or any federal official refuses to use the legend provided herein, the Contracting Officer, federal government agency, or any federal official must notify HERE prior to seeking additional or alternative rights in the Data.



Type B EULA Requirements

I - Definitions

The terms used in this Appendix L shall have the same meaning as defined in the main part of the Agreement.

“Sublicensed Software” shall mean the Telenav Functionality, which is sublicensed to End Users (Sublicensees) in accordance with Sections 2(a)(iii) and 2(b)(iii) of the Agreement.

“Sublicense(d)” shall mean the license given by Company to End Users in accordance with Sections 2(a)(iii) and 2(b)(iii) of the Agreement and this Appendix L.

II - EULA Requirements

Company’s End User license agreement must satisfy the following criteria:

1. No Source Code. Only the object code of the Telenav Functionality may be Sublicensed. Unless authorized in a separate agreement with Telenav, the source code may not be sublicensed.
2. End-User Documentation. End Users may be given the right to use Documentation, provided that such rights are limited to use in connection with the Sublicensed Software.

Whenever the context reasonably permits, any reference in this Exhibit L to Sublicensed Software shall also apply to the Documentation.

3. Limitations of Use. The End User’s right to use the Sublicensed Software must be limited to solely using the Sublicensed Software on the Company Product in which the Sublicensed Software is installed.
4. Other Versions and Updates. Company is entitled to update the Sublicense subject to the terms and conditions found in this Exhibit L.
Protection of Sublicensed Software. The Sublicense and End User’s rights must be limited to End User’s internal use purposes only and must not include any license, right or authorization to distribute, disclose, reproduce, resell further sublicense or publish any copy or portion of the Sublicensed Software to any other person. Except as expressly permitted in this Exhibit L, (or another written agreement with Telenav), End Users must not be given any rights to modify or create derivative works based on Sublicensed Software, or reproduce Sublicensed Software, or distribute any copies of Sublicensed Software, or disclose any Sublicensed Software to any third party, or decompile, disassemble or otherwise reverse engineer Sublicensed Software. End Users must as part of the contractual terms in the Sublicense acknowledge that Telenav and its licensors own the copyrights and other Intellectual Property in and to the Sublicensed Software.

5. Disclaimers Of Warranties. Company may not give any warranties regarding the Sublicensed Software to End Users on behalf of Telenav or its licensors.
6. Limitation of Liability. Company must, as a minimum requirement, limit its liability towards End Users to the amount paid to Company for the Sublicense.
7. Responsibility of Sublicensee. End Users shall, as part of the Sublicense, be made responsible for decisions made and actions taken based on Sublicensed Software. End Users shall as part of the contractual terms of the Sublicense be made aware that use of the Sublicensed Software may pose a risk of injury or death to the End User and others in situations that otherwise require the End User's undivided attention, End Users shall agree to observe all traffic laws and otherwise drive safely and only use the Sublicensed Software which the vehicle is stationary and in park. It shall further be stated in the Sublicense that it is End User's responsibility to ascertain the suitability of Sublicensed Software for any situation or application. It shall also be stated that the Sublicense defines a mutually agreed-upon allocation of risk and the Sublicense fees reflect such allocation of risk.
8. Termination.
 - a. Company shall, as part of the terms of the Sublicense, be entitled to terminate the Sublicense granted to an End User if the End User breaches terms and conditions set to comply with this Exhibit L. Telenav may instruct Company to terminate the Sublicense without undue delay if termination is warranted in accordance with the foregoing. Upon termination of the Sublicense, an End User shall be obliged to immediately cease all use of Sublicensed Software and to destroy all copies of Sublicensed Software within the possession or control of the End User.
 - b. Company shall, as part of the terms of the Sublicense, be entitled to terminate the Sublicense granted to an End User immediately if the Agreement between Company and Telenav is terminated.
9. Mandatory law. The requirements above shall not apply to the extent they contravene mandatory provisions of the law governing the Sublicense, but in such case, Telenav shall be notified about the changes.

1

2

3

4

5

6

Pass Through Requirements

A. Licensee agrees to provide an “about” page on the Company Product for Telenav to populate with proprietary rights notices denoting ownership and required attributions of itself and its third party content providers. Telenav will update the “about” page periodically to ensure third party content provider ownership and attribution information is up-to-date.

Licensee shall not remove any proprietary rights notices included in the third party content. The initial “about” page shall include the following information: TELENAV, INC.

The connected search feature is the intellectual property of Telenav, Inc.

Copyright © 2021, All rights reserved.