

## DRIVER ASSURANCE

**Mazda Drivers Assurance Plan**  
Check out [www.mymazda.com](http://www.mymazda.com), the website dedicated to you.

Manage your maintenance records, receive valuable offers, see the latest accessories, and much more!

**Mazda Roadside Assistance**

Exhilaration, liberation and inspiration, are great reasons to drive a Mazda car, truck, SUV or minivan. In addition to all the other great standard features, you also get peace of mind, our Emergency Roadside Assistance Plan, it's just a phone call away, 24 hours a day, 365 days a year, call **1-800-866-1998**

**Mazda "bumper-to-bumper" Limited Warranty**

We design and build every Mazda to give you driving pleasure now and far down the road. We're so confident in our quality that we cover the entire vehicle against defects in materials and workmanship

for 48 months or 50,000 miles, whichever comes first

**Mazda Service Transportation Solution**

Being without your Mazda may put a crimp in your day, if you do ever have to take your Mazda in for repairs don't worry, you're covered. With the Mazda Transportation Solution, you will be given a loaner car at no charge when your Mazda vehicle is in for warranty repairs.

For all the details, see your Mazda Dealer

This Quick Tips® guide is provided by Mazda North American Operations to make your Mazda ownership experience more convenient. It is not intended to replace your Owner's Manual.

If you have any questions about your vehicle, you are invited to contact your local dealer.

Or if you need additional help, feel free to call our **Customer Assistance Center at 1-800-222-5500**

Monday through Friday,  
9 a.m.- 4:45 p.m., Pacific  
9 a.m.-5:45 p.m., Eastern/Central

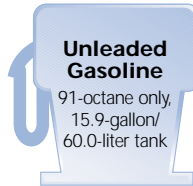

©2003 Calcar. Quick Tips® is a trademark of Calcar, made in USA 1/03 32.5M CG Mazda North American Operations reserves the right to change product specifications at any time without incurring obligations. 9999-95-079C-04QT

# MAZDA RX-8

## Quick Tips®

Reference  
Guide for  
Controls and  
Functions

2004



## DRIVER'S VIEW

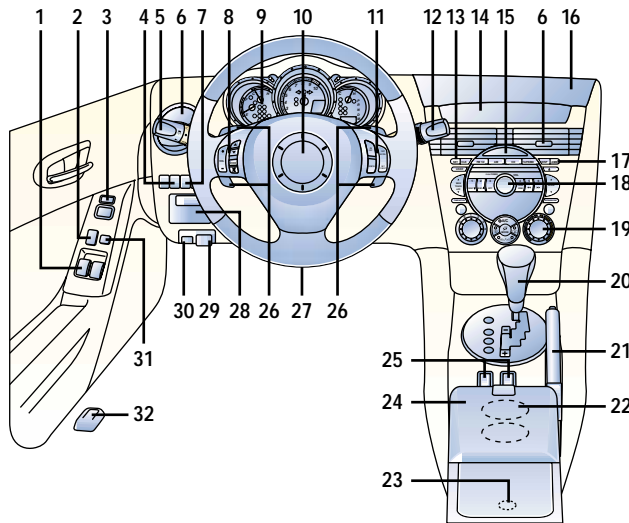











## Getting Started

RX-8 Quick Tips® are designed to quickly familiarize you with some important features of your RX-8

This Driver's View tab is your index to the Quick Tips®, locate the item you would like to learn more about and then turn to the listed tab

Be sure to see the tab called Getting Started, this section contains important operating tips about your RX-8

Items identified with a Rotary Engine symbol  call out important information

- |   |  |   |
|---|--|---|
| 1. Power window switches, see Switches/Locks  | 13. Clock, see Audio Systems   | 24. Console, see Console/Transmission   |
| 2. Power door locks, see Switches/Locks   | 14. Information display, see Owner's Manual  | 25. Seat warmer*, see Console/Transmission  |
| 3. Dual power mirrors, see Switches/Locks   | 15.  Hazard warning switch, Press on/off  |  26. Steering paddle switches (A/T only)*, see Transmission  |
|  4.  Instrument panel lighting, see Getting Started |  16. NAVI system*<br>System is used to locate street addresses, points of interest or cross streets: see your Owner's Manual for additional operating information | 27. Tilt steering-wheel lever, see Driver Controls  |
| 5. Turn signal/lighting control lever, see Driver Controls  | 17. Ambient temperature display  | 28. Storage   |
| 6. Air vents  | 18. Audio system, see Audio Systems  | 29.  Hood release handle   |
|  7. <sup>DSC</sup> Traction Control System*, see Getting Started   | 19. Climate control panel, see Climate Controls  | 30.  Remote trunk-lid release<br>Push to open trunk; main switch in glove box must be ON<br>Remote trunk-lid release lock-out, see Trunk                   |
| 8. Audio control switches*, see Driver Controls   | 20. Gearshift lever (A/T)*, see Transmission   | 31. Power window lock switch  |
|  9. Tire pressure monitoring system, see Getting Started   | 21. Parking brake lever, see Console/Transmission  |  32.  Remote fuel-door release<br>Use unleaded gasoline, 91-octane only |
| 10. Horn/Air bag  | 22. Cup holder   |   |
| 11. Cruise control, see Driver Controls   | 23. Accessory socket   |   |
| 12. Wiper/washer control lever, see Driver Controls   |  |   |

\*Denotes optional equipment

Always check the Owner's Manual for more operating information and safety features

Driver's  
View

## GETTING STARTED

 **Short trip driving procedure**

Any trip that is too short for the engine to reach normal operating temperature; needle in middle of temperature gauge indicates normal temperature

The following procedure should be followed when moving vehicle a short distance\*\*:

1. Start engine
2. Move vehicle
3. Warm engine for 5-minutes at idle
4. Raise engine speed to 3000 RPM for 10-seconds
5. Return to idle
6. Turn off engine

 **Tip: Warming up engine improves engine life**

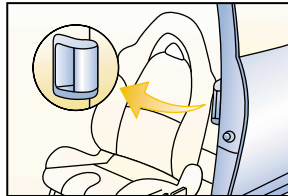

 **Tips: Close rear door first, then front door; damage may occur otherwise**

**To prevent alarm arming with passenger inside vehicle, driver must manually lock door by pressing lock knob**

 **RX-8 rotary engine precautions**

Check engine oil level when refueling. Rotary engine design uses an oil injection system in addition to lubrication of internal parts. It is important to maintain proper oil level.

 **Engine oil level warning light**

Indicates low engine oil if illuminated; pull over to a safe location; turn engine off and check engine oil level when engine is cool, add engine oil if necessary.

 **Rear doors**

*For a rear occupant to exit with a front passenger:*

1. Front occupant must release seatbelt
2. Front occupant must open door
3. Open rear door

*For a rear occupant to exit without a front occupant:*

1. Release front seat to forward position
2. Unlock and open front door
3. Open rear door

 **Instant Mobility System emergency flat tire repair kit (IMS)**

Temporary spare tire is not equipped with your Mazda, if tire repair is required, repair tire with emergency flat tire repair kit, see Owner's Manual.

If a temporary spare tire is required, consult your Authorized Mazda Dealer.

 **Tire pressure monitoring system**

Warning light illuminates for a few seconds when ignition is on. If tire pressure is too high or low, or tire temperature is too high, warning light will illuminate.

 **Traction Control System (TCS)\* / Dynamic Stability Control (DSC)\***

DSC light may occasionally flash while driving, this indicates that the DSC was performing a correction to help maintain your best vehicle control, if DSC light remains on, see your Mazda Dealer.

If DSC light remains on after disconnecting battery or jump-starting, you will need to perform a Steering Angle Sensor calibration procedure, after battery power is restored: Ignition ON; turn steering wheel to full left lock position; then full right lock position; turn ignition OFF, then ON.

 **Instrument panel lighting**

*With headlights on:*  
To brighten/dim turn thumbwheel up/down.

*Maximum illumination:*  
Rotate thumbwheel upward until click is heard; instrument cluster and information display illumination color goes from red to white.

*Headlights/parking lights OFF:*  
Instrument panel lighting defaults to maximum brightness.

*Headlights/parking lights ON:*  
Illumination changes brightness with dimmer switch adjustment.

\*Denotes optional equipment

\*\*Moving vehicle at a car wash or moving vehicle to access another vehicle would be considered a short distance.

Always check the Owner's Manual for more operating information and safety features

## Instrument Cluster

## INSTRUMENT CLUSTER

## GAUGES

## 1. Fuel gauge

## 2. Engine coolant temperature gauge

If above normal range, stop vehicle and turn off engine, check coolant level when safe

## 3. Speed unit selector

Select km/h or mph

## 4. Tachometer

## 5. Engine over-rev warning buzzer

The rotary engine design allows RPM ranges of up to 7000 RPM (A/T) and 9000 RPM (M/T), if you exceed a given RPM, a warning buzzer will remind you to up-shift to the next higher gear  
Always obey all local speed limits and traffic signs

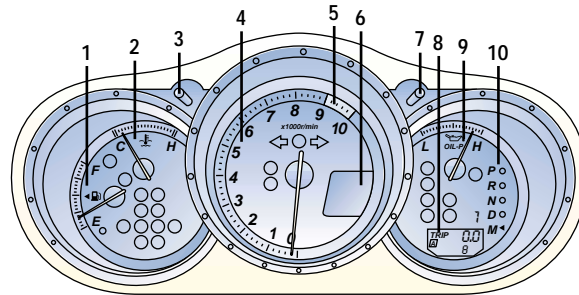

## 6. Speedometer

## 7. Odometer/trip odometer selector

Press to select among trip A, trip B, and odometer  
Press and hold to reset selected trip meter

## 8. Odometer/trip odometer

## 9. Engine oil pressure gauge,

Indicates normal engine oil pressure when needle is halfway between L and H with engine running

## 10. Manual mode gear indicator (A/T only)\*

Displays current gear of Sport AT during manual shift mode

## WARNING LIGHTS

## • Low fuel

## • Turn signals/hazard warning on

## • Anti-lock Brake System (ABS)\*

ABS malfunction, normal brakes only, dealer inspection required

## • CRUISE Cruise set, see Driver Controls

## • AT Automatic transaxle indicator

Dealer inspection required if light remains on

## • High beams on

## • Charging system warning light

Dealer inspection required

## • Tire pressure monitoring system, see Getting Started

## • Lights on

## • Traction Control System (TCS)\*/Dynamic Stability Control (DSC)\*, see Getting Started

## • DSC Traction Control System\* off, System turned off manually

## • CRUISE MAIN Cruise control main power on, see Driver Controls

• BRAKE Brake system  
Parking brake on/low fluid level• Check engine  
Dealer inspection required

## • Immobilizer system, see Locks

## • Engine oil level warning light, see Getting Started

## • Power steering malfunction

Dealer inspection required if light remains on

## • Air bag readiness

Front, side and curtain air bag malfunction; warning light constantly flashes or stays on or never comes on with ignition on, dealer inspection required

## • Door ajar

## • Always fasten safety belts

## • Low washer fluid level\*

## • Engine coolant level

## • Headlight auto leveling malfunction

\*Denotes optional equipment

Always check the Owner's Manual for more operating information and safety features

## Instrument Cluster

## Driver Controls

## DRIVER CONTROLS

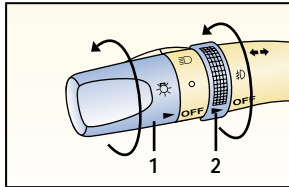
**Turn signal/lighting control lever**

**OFF** = Lights off

☽ = Tail, parking and dashboard lights on: Rotate knob (1) to first notch

☽ = Tail, parking, dashboard and headlights on: Rotate knob (1) to second notch

High beams on/off: Push forward/pull back to detent

To flash high beams: Pull back slightly and release

Turn signals right/left: move lever up/down

☽ = Fog lights on: Rotate (2); functions only with headlight low beams on

**Tip: Headlights switch off, parking lights remain on, if lights are left on and switch is in lock position or key removed**

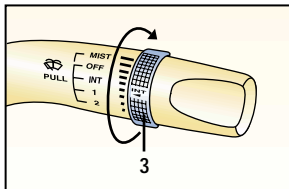
**Wiper/washer control lever**

Intermittent wiper:

One click down

To change interval speed: Rotate inner ring (3)

Normal wiper speed: Two clicks down

Fast wiper speed: Three clicks down

Single wipe: Push stalk up

Washer: Pull stalk back

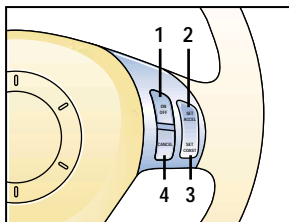
**Cruise control**

Operates above 25 mph

To activate: Press and release ON/OFF (1)

To set speed: Press and release SET/COAST (3) at desired speed

To accelerate: Press and hold RESUME/ACCEL (2); incremental acceleration: Press and release (2), each tap = plus 1 mph

To decelerate: Press and hold SET/COAST (3), release at desired

speed; or tap brake pedal, press and release (3) at

desired speed; incremental deceleration: Press and release (3), each tap = minus 1 mph

To cancel: Tap brake pedal, clutch pedal (manual transaxle) or press CANCEL button (4) or ON/OFF (1)

Return to preset speed after CANCEL button or braking: Press and release RESUME/ACCEL button (2)

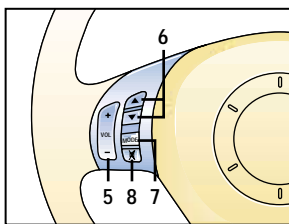
**Steering-wheel audio controls**

To increase/decrease volume: Press (5)

Radio: Press (6) to select preset stations

Cassette/CD/MD: Press (6) to select next selection/track

Press (7) to select AM, FM1, FM2, Tape, CD and MD mode

Press (8) to mute

**Tilt steering-wheel lever**

Pull lever located under steering-wheel down to unlock column, position tilt angle steering column position

**WARNING: Do not adjust steering-wheel while driving, you can lose control of vehicle**

\*Denotes optional equipment

Always check the Owner's Manual for more operating information and safety features

## Driver Controls

Switches/  
Locks

SWITCHES / LOCKS

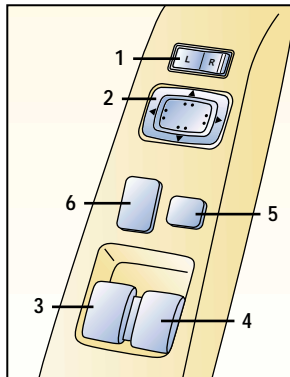

**Dual power mirrors**

Ignition switch must be in ACC or ON position

Switch is on driver's door

To adjust left/right mirror: Press selector switch (1) left/right, press switch (2) in direction of desired movement

**Tip:** To lock mirrors in place, move selector to center position

**Power window switches**

Ignition switch must be in ON position

Front windows controlled from the driver's armrest; passenger door has a separate switch

**Driver's window**

One-touch-down: Push down AUTO switch (3) firmly and release, window goes down all the way; pull switch back briefly to stop; press lightly and hold for normal operation

**Passenger window switch**

Press button (4) down and hold to open; pull back and hold to close

**Power window lockout switch**

Press button (5) down until clicks, only driver's window operates; press again and passenger windows function again

**Power door locks**

**Master front door lock switches**

To lock/unlock all doors: Press bottom/top of switch (6)

To lock doors without key: With door open, press bottom of door lock switch, exit car, close doors

To unlock: Use key to unlock driver's front door, rotate key to counter-clockwise position for more than one second to unlock other doors

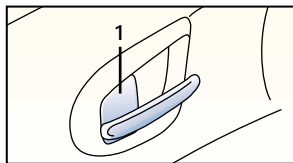

**Manual door locks**

**Lock button**

To lock: Press front of button (1) toward door handle

To unlock: Pull front of button away from door handle

**Tip:** Doors can be locked with key in ignition (chime sounds to alert you to key in ignition)

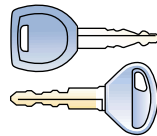

**Key**

Operates ignition and all locks

**Tip:** Use key number plate to purchase new key; store in safe place

**Immobilizer system**

Prevents engine from running unless coded key used; see Owner's Manual

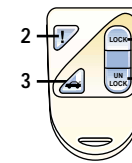

**Remote keyless entry system**

Functions only with ignition in OFF position

To lock doors: Press LOCK button (4); pressing again within 5 seconds causes doors to relock and horn to beep

To unlock: Press UNLOCK (5) for driver's door; press again within 5 seconds to unlock other doors

To open trunk: Press (3)

Panic alarm: Press ! (2); horn sounds and turn signals flash; to stop, press (2) again or turn ignition to ON position

If trunk fails to open: See Trunk Tab, then Remote trunk-lid release lock-out

\*Denotes optional equipment

Always check the Owner's Manual for more operating information and safety features

Locks

## HomeLink®

## HOMELINK®

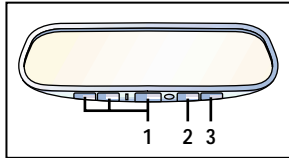
**HomeLink® Wireless Control System\***

Located on rear view mirror

To program or reprogram: Ignition must be off; hold transmitter for the device to be programmed between 1-3 inches to HomeLink®; press transmitter button and desired HomeLink® button (1) simultaneously until HomeLink® indicator light goes from slow to rapid flashing

Turn ignition on; verify device operation by pressing HomeLink® button (1) that was just programmed; repeat procedure for other buttons

**Rolling code synchronization procedure**

Refer to your garage door opener or device instruction manual to confirm your system is equipped with a rolling code feature

 **Tip: This procedure is easier done with the assistance of another person**

To synchronize: Press programming button on garage door opener motor; press and release the programmed HomeLink® button 2 times within 30 seconds of pressing the garage door opening motor programming button

Some devices may require you to press and release a third time to complete programming procedure

**Auto-dimming rear view mirror**

Auto-dimming function changes are based on outside lighting conditions and if bright headlights are visible in rear view mirror Press on (2), off (3)

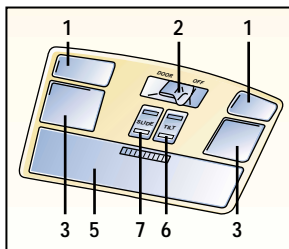
**1. Map/reading light**

Press on/off

**2. Interior light switch**

DOOR = light on when door open  
ON = light always on  
OFF = light always off

**3. Front interior light****4. Rear interior light****5. Sunglass holder**

Press concaved lip then open

**6. Sunroof tilt switch\***

Press rear of switch to tilt rear of sunroof  
Press front of switch to close

**7. Sunroof slide switch\***

Press rear of switch to open sunroof  
Press front of switch to close

**Illuminated visor mirrors**

Mirrors lighted when covers open; off when closed

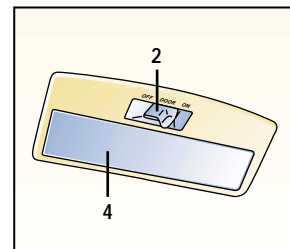

\*Denotes optional equipment

Always check the Owner's Manual for more operating information and safety features

Interior  
Lights

Console/  
Transmission

CONSOLE / TRANSMISSION

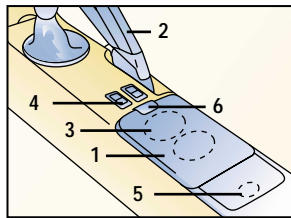

**1. Console**

Press button (6) and slide cover rearward until it clicks

**2. Parking-brake lever**

To engage: Pull up

To release: Pull up slightly while depressing button at front of lever, lower hand brake lever

**3. Cup holders**

**4. Seat warmer\***

Press on/off switch; indicator light on when activated

**5. Accessory socket**

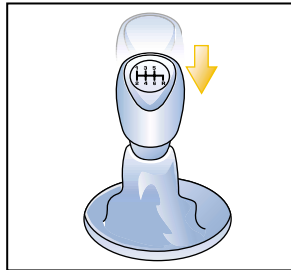

**Manual transmission\***

Depress clutch pedal to start engine and change gears, push shifter downward when selecting reverse gear



**WARNINGS: Do not shift into 1st above 20 mph or clutch failure could occur**

**Resting your foot on clutch pedal while driving and using the clutch to hold your vehicle at a stand still while waiting on a hill may reduce clutch life**

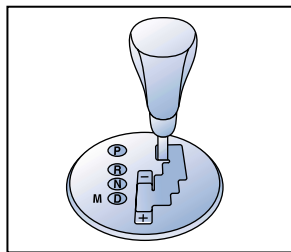

**Tip:** Torque converter lock-up improves fuel economy and can feel like an additional gear change



**WARNING:** Placing shift lever in P position without setting parking brake may not hold vehicle, always set parking brake

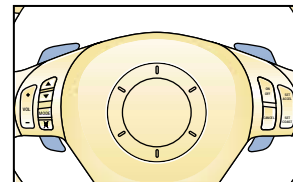

**Automatic transmission\***

**P = Park**

To move gearshift from Park: Press firmly on brake pedal, then move gearshift to gear selection

**R = Reverse**

**N = Neutral** No gear engaged

**D (Overdrive)**

For normal driving: Shifts through four forward gears automatically



**Sport AT manual shift mode\***

Move shift lever return from D to M; then M to D for automatic mode

**M (Manual)**

Manual gear selection is achieved by moving shifter back to upshift and forward to downshift. Shift and gear position indicator located in the instrument panel, M will be illuminated for manual mode, numeral for gear position will be shown next to shift position indicator



**Steering shift switches (A/T only)\***

Upshift/downshift: pull either switch up/down, see Owner's Manual

\*Denotes optional equipment

Always check the Owner's Manual for more operating information and safety features

Transmission



## SEATS

**Manual controls**

- 1. Fore-aft adjustment**  
Lift lever and hold, slide seat, release lever
- 2. Raise/lower seat**  
Pull/push lever and release
- 3. Seatback angle**  
To adjust: Lift and hold lever, lean forward or backward, release lever

 **Tip: Side-impact air bags\* deploy from outboard side of driver and front passenger seatbacks**

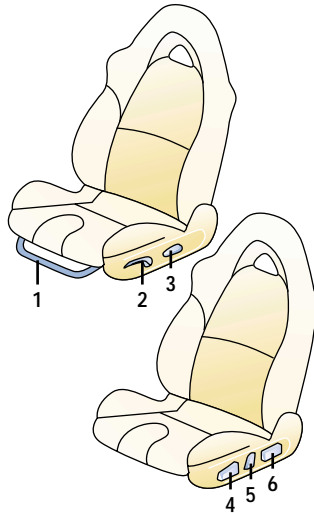
**Power driver's seat\***

- 4. Raise/lower front of seat cushion**  
Pull/push front of switch vertically
- Fore/aft adjustment**  
Slide switch horizontally
- Raise/lower rear of seat cushion**  
Pull/push rear of switch vertically
- 5. Seatback angle**  
Press front/rear of switch
- 6. Lumbar adjustment\***  
Press front/rear of switch to increase/decrease firmness

**Seat warmer\*,**  
see Console/Transmission

-  **WARNINGS: Do not adjust seats while driving, you can lose control of vehicle**  
**Safety belts must always be worn when vehicle is in motion**  
**Air bags are supplemental and do not replace safety belt usage**

**Always wear your safety belt and properly secure children 12 and under in the rear seat**

**Never place rear-facing infant-safety seat in front of any air bag, an infant is in serious danger of being injured or killed**

**If you choose to install a forward-facing child-safety seat in the front seating position, move vehicle seat as far back as possible**

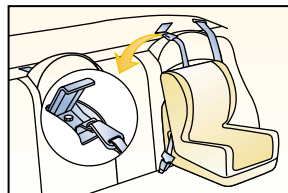
 **Child-safety seat**

To install in rear outboard seats: Use dual locking mode retractor seat belts: see Owner's Manual for proper installation and child seat tether and LATCH system instructions

-  **WARNING: Use age appropriate child restraints, see Owner's Manual and state or province laws**

**Dual locking mode lap/shoulder belt retractor (front passenger and rear safety belts only)**

**Emergency locking mode:** Belt locks only on hard braking/ cornering or impacts of about 5 mph or more

**Automatic locking mode:** Must be used when installing child-safety seat

To activate: Pull webbing until fully extended from retractor until click is heard; belt will only tighten when released

To disengage: Unbuckle belt and allow webbing to retract fully

\*Denotes optional equipment

Always check the Owner's Manual for more operating information and safety features

Climate Controls

CLIMATE CONTROLS

1. Air flow selections

- = air to dash
- = air to dash and floor
- = air to floor
- = air to floor and windshield

2. Fan control

Rotate knob between 0 (OFF) and 4 (HIGH)

3. Temperature control

Cooler/warmer = rotate knob counterclockwise/clockwise

4. A/C = air conditioner

Press to turn on/off

5. Air intake control

- = recirculate inside air; use for maximum cooling
- = fresh air

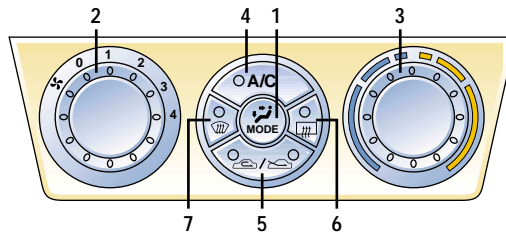

**WARNING:** Do not use position in cold weather, windows may fog and hamper vision

**Tips:** To help prevent windshield fogging in humid weather, select before starting engine. To prevent moisture buildup, never drive with system off. Objects placed under the front seats may interfere with air flow to the rear.

**6. Rear window defogger**  
Press on/off; shuts off with ignition; also operates heated side mirrors\*

**Control positions for maximum defrost**  
Fan to maximum, temperature to maximum hot, selected

**7. Front windshield defogger**  
A/C switches ON and air intake switches to fresh air

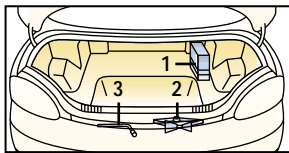

Trunk

To open: Use key, remote trunk-lid release or remote keyless entry fob

**Remote trunk-lid release,** see Driver's View



**Remote trunk-lid release lock-out**  
Switch in ON position, remote trunk release

functions normal; OFF position disables system; located in glove box

**1. Instant Mobility System emergency flat tire repair kit (IMS)<sup>†</sup>,** see Getting Started

2. Jack/jack handle

3. Lug wrench

Tire economy and tips

Check pressure regularly when tires are cold, maintain correct front-end alignment and tire balance; rotate tires at the mileage shown in the Maintenance Guide; see Owner's Manual for rotation chart

Tire pressure

P225/55R16 94V,  
P225/45R18 91W

Front/rear: 32psi cold

**Tips:** Correct tire pressure ensures safe handling and ride comfort if you experience pull/drift while driving, possible causes may be road crown, tire pressure, or wheel alignment. The suspension is sport-tuned with firmer ride for optimum handling and response

Tire chains\*<sup>†</sup>

Tire chains can damage aluminum wheels; use on steel wheels only

**Tips:** Use only SAE class "S" chains, install only on rear tires; install as tightly as possible and retighten after driving 1/4-1/2 miles; chains may affect handling. Never exceed 30 mph with tire chains



Luggage compartment internal safety release

Allows you to escape should you become locked in trunk. Slide illuminated release lever in direction of arrow; lever will glow if it has been exposed to light. Located on interior trunk lid

\* Denotes optional equipment  
<sup>†</sup> See Owner's Manual

Always check the Owner's Manual for more operating information and safety features

Trunk

## Audio Systems

### AM / FM STEREO / CASSETTE / CD

#### 1. Power/Volume

Press to turn on/off; rotate to increase/decrease volume

 **Tip: Press (8) and (9) together to turn radio on**

#### 2. Repeat

Press to replay current CD/ tape selection

#### 3. Disc up ^ †

Press to skip forward to beginning of next CD

#### 4. Disc down v †

Press to skip back to beginning of previous CD

#### 5. Tune/Auto-Memory

Tune: Rotate counterclockwise/ clockwise for lower frequency/ higher frequency

Radio: Press and hold until a beep is heard; system automatically scans and temporarily stores six strong stations in each band; press again to cancel

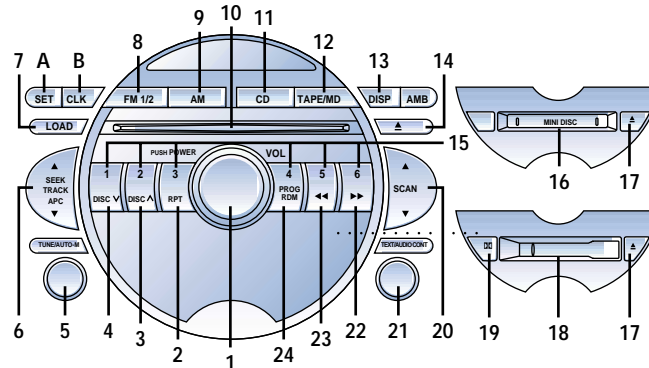

#### 8. FM1/2

Press to select between FM1/FM2 station preset buttons (15)

#### 9. AM

Press to select AM frequency band

#### 10. CD slot

#### 21. Text/Audio Control

Audio control: Press to select BASS/MID/TREBLE/FADE/ BALANCE/BEEP ON/ALC OFF/ ALC LEVEL 1, 2, 3/AUDIO PLT ON\*\*†; rotate right/left to adjust selected feature

#### 6. SEEK/TRACK/APC

Radio: Press ▲ / ▼ to automatically seek higher/ lower frequency

CD: Press ▲ / ▼ to select next/previous track

Tape: Press ▲ / ▼ to automatically advance tape to beginning of next selection/ replay selection; to stop this operation, press button again

#### 7. LOAD\*

To load multiple discs: Press and hold LOAD (7) until beep is heard; insert CD when "In" is displayed

To eject disc: Press Eject (14)  
To eject specific disc: Press and hold Eject (14) until beep is heard; within five seconds press the desired tray number 1-6 (15)

#### 11. CD

Press to play CD

#### 12. Tape\*/MD\*

Press to play Mini-disc Player/ cassette tape

#### 13. DISP\*

Press: Changes display during MD play

#### 14. CD eject button

15. Memory preset buttons  
To set: Tune to station, press and hold until beep is heard

#### 16. Mini Disc slot\*

#### 17. Eject button\*

#### 18. Cassette door\*

19. Dolby® Noise Reduction\*  
Reduces tape noise and hiss; press to activate/deactivate

#### 20. Scan

Press to briefly sample next listenable selections; functions in all modes

 **Tip: Automatic Level Control (ALC) automatically adjusts audio volume/quality depending on vehicle speed**

#### 22. Fast forward ►►

Press to fast forward through a track

#### 23. Reverse ◀◀

Press to reverse through a track

#### 24. Program Random†

Press to enable/cancel

#### Clock

To set: With ignition in ACC or ON position, press (B) and hold until beep sounds; 12 hr/24 hr will be displayed; press (A) to select; press (B) again while selection is flashing; Hr ADJUST displays; press (A) to select hr; press (B) when done, do the same to set minutes

\* Denotes optional equipment

\*\* Bose audio system only

† For use with cassette tape player, MD player, or CD changer\*

Always check the Owner's Manual for more operating information and safety features

## Audio Systems

Under Hood

UNDER HOOD

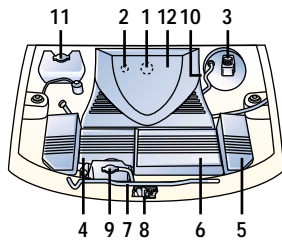

1.3-liter 13B

- 1. Engine oil filler cap**  
SAE 5W-20  
Remove engine cover (12) to access engine oil dipstick and oil filler cap
- 2. Automatic transmission fluid dipstick\***  
Check with engine on at operating temperature; fluid level should be within cross-hatched area/between top two notches on dipstick
- 3. Brake/Clutch\* fluid reservoir**  
Fill to MAX mark with DOT 3 fluid; check with cap on
- 4. Battery**
- 5. Fuse block**
- 6. Air filter**
- 7. Hood support rod**
- 8. Hood latch**  
Push hood latch to the left, open hood
- 9. Engine coolant reservoir**  
Level should be between F and L lines when cold  
**⚠️ WARNING: Never remove coolant reserve tank cap while engine is running or hot; you could get burned**
- 10. Engine oil dipstick**  
Check with engine off and at operating temperature; fluid level should be between F and L marks on dipstick
- 11. Windshield washer reservoir**  
Fill with windshield washer fluid
- 12. Engine cover**

\* Denotes optional equipment  
† See Owner's Manual

**Break-in period**

First 600 miles: Drive at varying road and engine speeds; avoid full throttle, rapid acceleration or kick-down of transmission

Do not use special "break-in" oils  
**Anti-lock Braking System (ABS)\***  
ABS automatically reduces hydraulic pressure to any wheel on the verge of locking up. You may feel a slight pulsing of the brake pedal and hear a clicking noise; this tells you the ABS is functioning properly; increase pressure on pedal for maximum braking

**☀️ Tips: Maintain constant pressure on the brake pedal. Do not pump the brakes**

**ABS self test\***

A self-diagnostic test is performed when starting; you may feel some brake pedal pulsation and hear some noise, this is normal

**NORMAL SERVICE INTERVALS**

7,500 miles	A
15,000 miles	A B E
22,500 miles	A
30,000 miles	A B C E
37,500 miles	A D
45,000 miles	A B
52,500 miles	A E
60,000 miles	A B C F
67,500 miles	A
75,000 miles	A
82,500 miles	A
90,000 miles	A

**Unique driving conditions†**

Every 5,000 miles change oil/filter, inspect coolant level, lights, brake/clutch fluid, tire pressure/wear, locks/hinges and washer fluid

**Normal maintenance notes**

Rotate tires every 7,500 miles or sooner if needed; replace cabin air filter every 25,000 miles or 24 months

- A. Change:** Engine oil/replace filter  
Lube: Locks and hinges
- B. Inspect:** Disc brakes
- C. Inspect:** Drive belts, fuel lines, hoses, and connections, brake lines and hoses, steering operation and linkages, front and rear suspension ball joints, driveshaft dust boots, chassis and body bolts, exhaust system heat shields, cooling system, and bolts and nuts on seat
- D. Replace:** Air filter, spark plugs
- E. Clean:** Air filter
- F. Replace:** Manual transmission and rear differential oil, engine coolant

Always check the Owner's Manual for more operating information and safety features