

DRIVER ASSURANCE

Mazda Drivers Assurance Plan
Check out www.mymazda.com, the website dedicated to you.

Manage your maintenance records, receive valuable offers, see the latest accessories, and much more!

Mazda Roadside Assistance
Exhilaration, liberation and inspiration, are great reasons to drive a Mazda car, truck, SUV or minivan. In addition to all the other great standard features, you also get peace of mind, our Emergency Roadside Assistance Plan, it's just a phone call away, 24 hours a day, 365 days a year, call **1-800-866-1998**

Mazda "bumper-to-bumper" Limited Warranty

We design and build every Mazda to give you driving pleasure now and far down the road. We're so confident in our quality that we cover the entire vehicle against defects in materials and workmanship

for 48 months or 50,000 miles, whichever comes first

Mazda Service Transportation Solution

Being without your Mazda may put a crimp in your day, if you do ever have to take your Mazda in for repairs don't worry, you're covered. With the Mazda Transportation Solution, you will be given a loaner car at no charge when your Mazda vehicle is in for warranty repairs.

For all the details, see your Mazda Dealer

This Quick Tips® guide is provided by Mazda North American Operations to make your Mazda ownership experience more convenient. It is not intended to replace your Owner's Manual.

If you have any questions about your vehicle, you are invited to contact your local dealer.

Or if you need additional help, feel free to call our

Customer Assistance Center at 1-800-222-5500

Monday through Friday,
9 a.m.-4:45 p.m., Pacific
9 a.m.-5:45 p.m., Eastern/Central

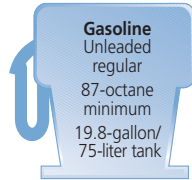

©2004 Calcar, Quick Tips® is a trademark of Calcar, made in USA 6/04 35,407 DOT Mazda North American Operations reserves the right to change product specifications at any time without incurring obligations. 9999-95-029C-05QT

2005

MAZDA MPV

Quick Tips®

Reference
Guide for
Controls and
Functions



DRIVER'S VIEW

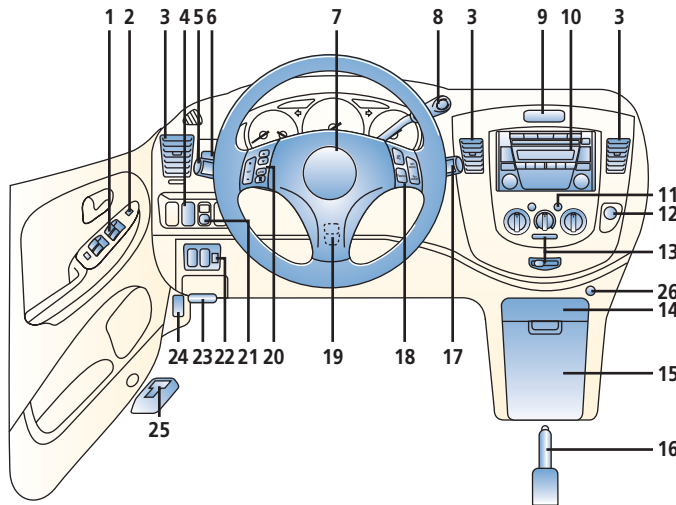

**Getting Started**

MPV Quick Tips® are designed to quickly familiarize you with some important features of your MPV

This Driver's View tab is your index to the Quick Tips®, locate the item you would like to learn more about and then turn to the listed tab

Be sure to see the tab called Getting Started, this section contains important operating tips about your MPV

Items identified in blue text call out important information

- | | | |
|---|--|--|
| <p>1. Power window switches,
see Switches/Locks</p> <p>2. Power door locks,
see Switches/Locks</p> <p>3. Air vents</p> <p>4. ^{TCS}_{OFF} Traction control system*</p> <p>5. Turn signal/lighting control lever,
see Getting Started</p> <p>6. Power outside mirror switch, see Switches/Locks</p> <p>7. Horn and driver's air bag</p> <p>8. Gear selector lever,
see Transaxle</p> | <p>9. Hazard warning switch
Push on/off</p> <p>10. Audio system,
see Audio Systems</p> <p>11. Rear window defroster switch</p> <p>12. 12V powerpoint</p> <p>13. Climate control panel,
see Climate Controls</p> <p>14. Cup holder</p> <p>15. Front console</p> <p>16. Parking brake lever</p> <p>17. Wiper/washer lever,
see Getting Started</p> <p>18. Cruise control,
see Getting Started</p> <p>19. Tilt steering-wheel lever
Pull lever down, position wheel; push lever up</p> | <p>20. Audio control switches,
see Getting Started</p> <p>21.  Instrument panel lighting
Headlights on: To brighten/dim, turn thumb-wheel up/down</p> <p>22. Power sliding door switches*, see Getting Started</p> <p>23.  Hood release handle</p> <p>24. Fuse panel</p> <p>25. Remote fuel door release</p> <p>26. Passenger air bag deactivation indicator light,
see Getting Started</p> |
|---|--|--|

*Denotes optional equipment

Always check the Owner's Manual for more operating information and safety features

Driver's
View

GETTING STARTED

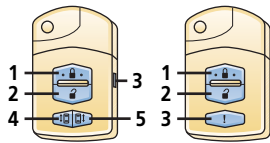

Remote Keyless Entry System

To lock doors: Press button (1); pressing again within 5 seconds causes doors to relock and horn to beep

To unlock: Press button (2) for driver's door; press again within 5 seconds to unlock other doors

Panic alarm: Press button (3) for 1 second; horn sounds, hazard warning lamps flash; to stop press any button on the transmitter

Power sliding doors*: Press (4/5) for 1 second to open/close left/right doors

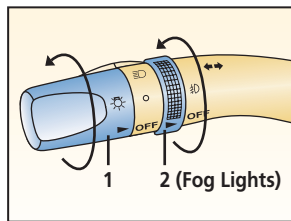

Turn signal/lighting control lever

OFF = Lights off

= Tail, parking and dashboard lights on: Rotate knob (1) to first detent

= Tail, parking, dashboard and headlights on: Rotate knob (1) to second detent

High beams on/off: Push lever forward to detent/pull back to detent

To flash high beams: Pull lever back slightly and release

Turn signals right/left: Move lever up/down

= **Fog Lights On**: Rotate knob (2); functions only with headlight low beams on

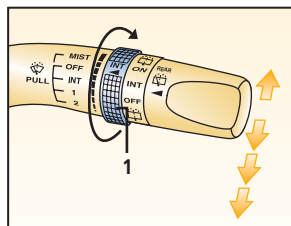

Front wiper/washer control lever

To activate interval wipers: Push lever down to first detent and rotate knob (1) to desired speed

To activate normal wiper speed: Push down to second detent

To activate high speed: Push lever down to third detent

To activate washer: Pull lever back and release

To activate mist: Push lever up and release

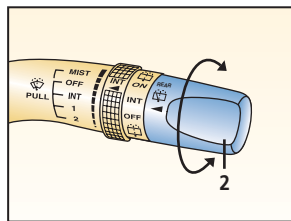

Rear wiper/washer control lever

To activate rear interval wiper: Rotate knob (2) up to INT

To activate rear normal speed wiper: Rotate knob (2) up to ON

To activate rear washer: Rotate knob (2) to and release

*Denotes optional equipment

Always check the Owner's Manual for more operating information and safety features

Getting Started

GETTING STARTED

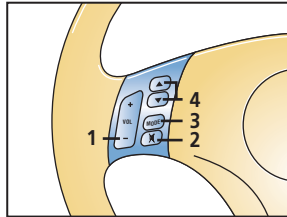
**Steering-wheel audio controls****1. Volume**

Increase/decrease volume: Press

2. Mute

Press to mute

3. Mode

Press to select FM1, FM2, AM1, CD, Sirius*, Tape* or MD*

4. ▲ / ▼ Seek

Radio: Press to select preset stations

Press for about 2 seconds until beep sound is heard to seek higher or lower frequency

Cassette*/CD/MD*: Press (4) to select next selection/track

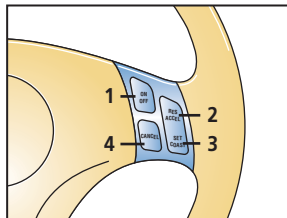
**Cruise control**

Operates above 25 mph

To activate: Press and release ON/OFF (1)

To set speed: Press and release SET/COAST (3) at desired speed

To accelerate: Press and hold RES/ACCEL (2); incremental acceleration: Press and release (2), each tap = plus 1 mph

To decelerate: Press and hold SET/COAST (3), release

at desired speed; or tap brake pedal, press and release (3) at desired speed; incremental

deceleration: Press and release (3), each tap = minus 1 mph

To cancel: Tap brake pedal, press CANCEL button (4) or ON/OFF (1)

Return to preset speed after

CANCEL button or braking:

Press and release RES/ACCEL

button (2)

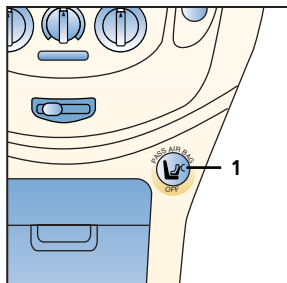
**Passenger air bag deactivation indicator light**

Front air bag deactivation indicator light (1) provides current status of front passenger air bag and pretensioner system

If total seated weight on front passenger seat is less than approximately 66 lb., front passenger air bag deactivation indicator light illuminates, air bag/pretensioner will not deploy/activate in an accident

If the total seated weight is greater than approximately 93 lb., light does not illuminate, and the air bag/pretensioner will deploy/activate in an appropriate accident, see Owner's Manual for additional information on this feature and the air bag system

*Denotes optional equipment

Always check the Owner's Manual for more operating information and safety features

Getting Started

Getting Started

GETTING STARTED

Power sliding doors*

The power sliding doors can be opened/closed by using: Exterior/interior door handles, keyless remote, lower dashboard power sliding door switches and one switch on each sliding door post

⚠ WARNING: Read all information and warnings related to power sliding doors in Owner's Manual

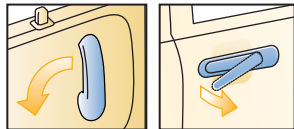

Opening/closing using door handles

Power sliding doors automatically open/close by sliding door approximately 2" in desired direction from fully opened/closed positions; buzzer will sound before door operates

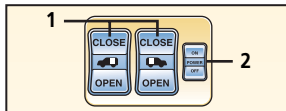

Operation from driver's seat

Power sliding doors main switch: Press (2) to disable/enable system
Opening/closing using switches: Stop vehicle, shift into park and apply parking brake; unlock sliding doors and press main switch (2) to ON position; press left/right switches (1) to open/close
Press switch for 1 second, doors automatically open or close after beep sounds; press again to stop sliding doors while they are opening/closing
If power sliding doors malfunction and beep sounds continuously; press main switch to OFF position to disable, see your Mazda Dealer

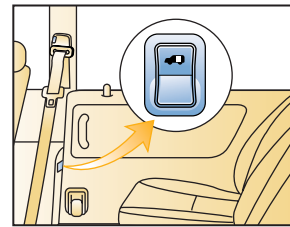

Operation from rear seats

Press switch for 1 second, doors automatically open or close after buzzer sounds; press again to stop

⚡ Tips: The system operates only in PARK position

The system may not operate correctly if battery voltage is low

⚡ Tip: Each time switch is pressed, a beeper will sound, this is normal

⚡ Tip: If the system is completely inoperative, both sliding doors can be operated manually

⚡ Tip: Make sure MAIN SWITCH is in ON position

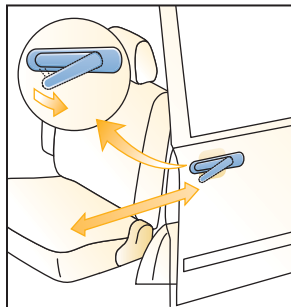

Manual sliding door

Closing/opening sliding door from the outside: Pull the door handle outward to release the lock, slide door front/rear

Closing/opening sliding door from inside: Pull door handle downward, open/close the door by sliding toward the front/rear

⚡ Tip: Make sure fuel lid is closed before opening left side sliding door; fuel lid cannot be opened with left sliding door open

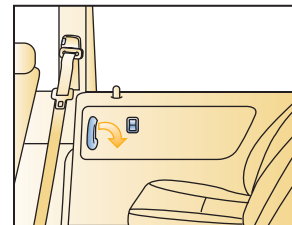

*Denotes optional equipment

Always check the Owner's Manual for more operating information and safety features

Getting Started

Instrument Cluster

INSTRUMENT CLUSTER

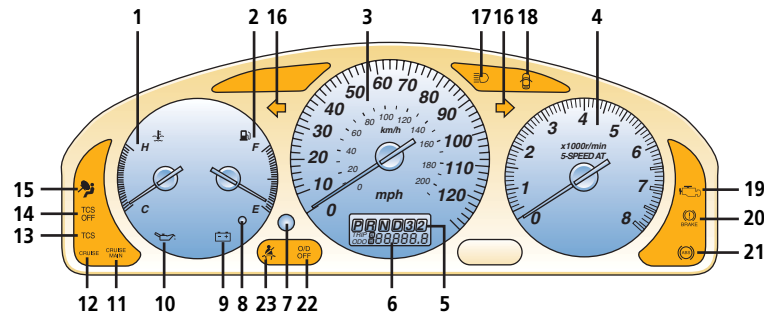

GAUGES

1. Engine coolant temperature gauge

If above normal range, stop vehicle and turn off engine; check coolant level when safe

2. Fuel gauge

19.8-gallon/75-liter tank

3. Speedometer**4. Tachometer****5. Gear indicator****6. Odometer/trip meter****7. Odometer/trip meter select button**

Press to select among trip A, trip B and odometer

Press and hold to reset selected trip odometer

8. Low fuel level

WARNING LIGHTS

9. Charging system warning light

Dealer inspection required

10. Low engine oil pressure warning light

Stop vehicle and turn off engine; check oil level

11. Cruise main indicator

System ON/OFF
See Getting Started

12. Cruise control,

see Getting Started

13. TCS Traction Control System*

Light flashes when in use; dealer inspection required if light remains on

14. Traction Control System* off

System turned off manually or malfunctioning; dealer inspection required

15. Air bag readiness

Front or side air bag malfunction, warning light constantly flashes, stays on or never illuminates with ignition on, dealer inspection required

16. Turn signals/hazard warning on**17. High beams on****18. Door ajar****19. Check engine**

Possible faulty emission control, dealer inspection required, or fuel filler cap not tight

20. Brake system

Parking brake on/low fluid level

21. Anti-lock Brake System (ABS)

ABS malfunction, normal brakes only, dealer inspection required

22. Overdrive off indicator,

see Transaxle
Lights when the overdrive button is in the off position

23. Always fasten safety belts

*Denotes optional equipment

Always check the Owner's Manual for more operating information and safety features

Instrument Cluster

Interior Lights

INTERIOR LIGHTS

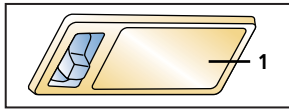

1. Liftgate light
 OFF = Light always off
 ON = Light on if door open



2. Rear interior light
 ON = Light always on
 DOOR = Light on if door open
 OFF = Light always off

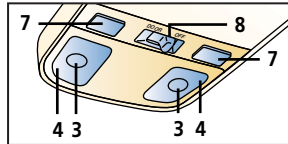

3. Map lights
 On/off: Press switches (7)

4. Interior lights
 Slide switch (8)
 OFF = Lights always off
 DOOR = Lights on if door open
 Rotate switch (9) clockwise/
 counterclockwise for DOOR/OFF

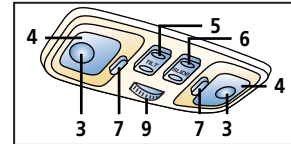

5. Sunroof tilt switch*
 Operates only with ignition on
 To tilt/close: Press and hold rear/front of switch

6. Sunroof slide switch*
 Operates only with ignition on
 To open: Press and hold rear of switch until panel is in desired position
 To close: Press and hold front of switch

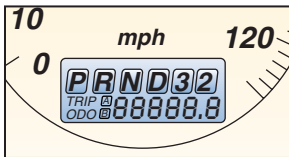
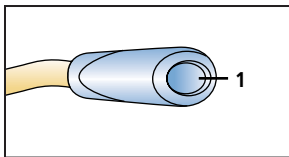

Automatic transaxle

P = Park
 To move gear selector lever from Park: Press firmly on brake pedal

Tip: To shift from P smoothly, depress brake pedal firmly before moving shift lever, ignition switch must be in ACC or ON position

R = Reverse
N = Neutral
 No gear engaged

D (Overdrive)
 For normal driving: Shifts through five forward gears automatically

Tip: Torque converter lock-up improves fuel economy and can feel like an additional gear

D (Overdrive Off)

Press overdrive off switch (1) to disengage/engage overdrive; indicator light on instrument panel will illuminate; shifts through four forward gears automatically
 Provides extra power and increased engine braking

2 = Second
 Use for engine braking when 3rd is not sufficient
 Use to reduce wheel spin when starting on slippery surfaces

*Denotes optional equipment

Always check the Owner's Manual for more operating information and safety features

Transaxle

Switches/
Locks

SWITCHES / LOCKS

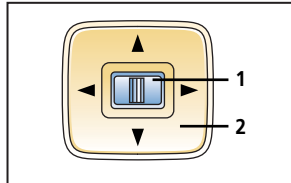

Power remote outside mirrors*

Ignition switch must be in ACC or ON position

To adjust left/right mirror: Slide selector switch (1) left/right, press perimeter switch (2) in direction of desired mirror movement

Tip: To lock mirrors in place, move switch (1) to center position

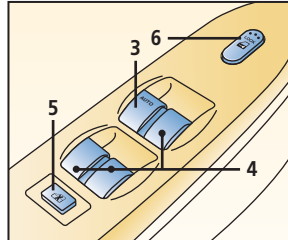

Power window switches

Ignition switch must be in ON position
All windows controlled from the driver's armrest; passenger doors have separate switches

Driver's window

One-touch-down: Push down AUTO switch (3) firmly and release, window goes down all the way; pull switch back briefly to stop; press lightly and hold for normal operation

Passenger window switches

Push switch (4) down and hold to open; pull back and hold to close

Power window lockout switch

Press button (5) down until clicks, only driver's window operates; press again and passenger windows function again

Master front door lock switch

To lock/unlock all doors: Press front/rear of switch (6)

To lock doors without key: With door open, press front of switch (6), exit vehicle, close doors

To lock/unlock with key: Turn key in driver's door clockwise/ counterclockwise

Tip: Doors can be locked with key in ignition (chime sounds to alert you that key is in ignition)

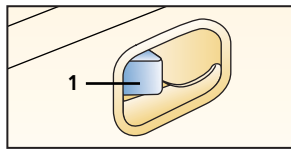

Door lock buttons

1. Front door lock buttons
To lock: Press front of lock button
To unlock: Pull lock button out
2. Sliding door lock buttons
To lock: Push button down
To unlock: Pull button up

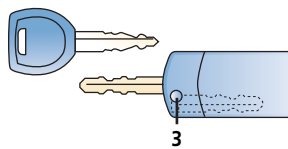
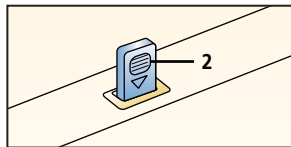

Key

Operates ignition and all locks

Tip: Use key number plate to purchase a new key; store in safe place separate from vehicle

Retractable key

To fold/unfold press release button (3)

Remote Keyless Entry System, see Getting Started

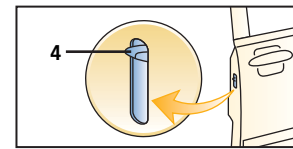

Child-safety locks

Located on the front edge of rear doors

To activate: Push tab (4) down; door opens from outside only
To cancel: Pull tab up

WARNING: Since children may access either rear door, child-safety locks for both rear doors should be activated

*Denotes optional equipment

Always check the Owner's Manual for more operating information and safety features

Locks

SEATS

Manual seat controls

1. Fore-aft adjustment

Lift lever, slide seat

2. Head restraint

To raise/lower: Pull up/push stop-catch (8) and push down

3. Seatback angle

To adjust: Lift and hold lever, lean forward or backward, release lever

4. Seat tilt (Driver's only)

Rotate front/rear dial to change angle of seat front/rear

5. Lumbar adjustment (Driver's only)

Power driver's seat controls

6. Fore/aft adjustment

Slide switch horizontally

Raise/lower seat cushion

Pull/push center vertically

Raise/lower front of seat

Pull/push front vertically

Raise/lower rear of seat

Pull/push rear vertically

7. Seatback angle

Press front/rear of switch

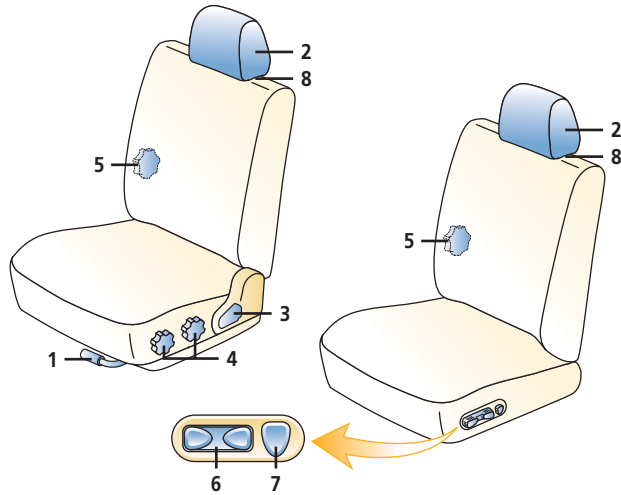

Shoulder belt height adjustment

To raise/lower belt: Push button (1) and move belt to desired position

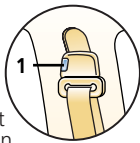

WARNING: Make sure adjuster locks in one of its positions

Removing and reinstalling front seats for modification purposes is dangerous and may compromise the air bag system

WARNING: Do not adjust seats while driving

Safety belts must always be worn when vehicle is in motion. All air bags are supplemental and do not replace safety belt usage

Always wear your safety belt and properly secure children 12 and under in a rear seat. Use age appropriate child restraints and safety seats, see Owner's Manual and state or province laws

Never place rear-facing infant-safety seat in front of any air bag, an infant is in serious danger of being injured or killed. If you must install a forward-facing child-safety seat in the front seating position, move vehicle seat as far back as possible

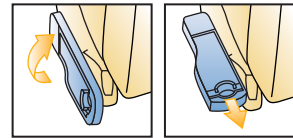

Front passenger seat side table

Pull up to locked position; push down to verify table is secure

Expand table rearward by pulling out the rear

Lowering side table: Pull lever (2) under table frontal section and fold down completely

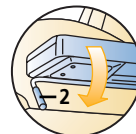

WARNING: Do not use front passenger seat side table while vehicle is in motion

*Denotes optional equipment

Always check the Owner's Manual for more operating information and safety features

Seats

SEATS

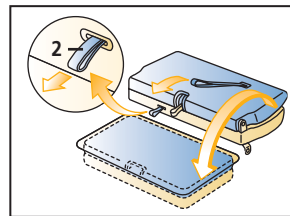
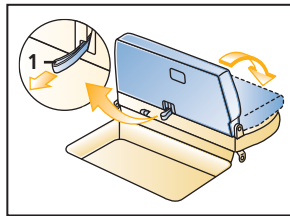

Third-row seat

Insert seat belts in retainers; remove head restraints; pull strap (1), push seatback toward front of vehicle until it locks with a click. Pull strap (2); lift seatback and seat bottom up to vertical; gently lower the seat into seat well.

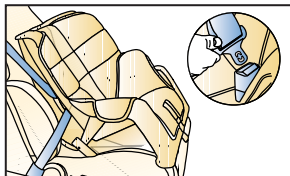

Child-safety seat

To install in 2nd row outboard seats: Use dual locking mode retractor seat belts; see Owner's Manual for proper installation and child seat tether and LATCH system instructions.

⚠ WARNING: Read all information and warnings in Owner's Manual and attached to seat before using child-safety seat

Safety belt emergency locking mode

Belts lock only on hard acceleration, braking, cornering or impacts of about 5 mph or more.

Automatic locking mode (front passenger and all rear safety belts only)

Must be used when installing child-safety seat
 To activate: Pull webbing fully out of retractor until click is heard; belt will only tighten
 To disengage: Unbuckle belt and allow webbing to retract fully

⚠ WARNING: Make sure all adjustable seats are properly latched, because during a sudden stop or collision the seat or seatback could move, causing injury

*Denotes optional equipment

Always check the Owner's Manual for more operating information and safety features

Child-safety Seats

Climate Controls

CLIMATE CONTROLS

Front climate controls

1. Temperature control

Rotate knob to blue for cool, red for warm

Control positions for maximum defrost

Fan to maximum, temperature to maximum hot, air flow selector knob to 

2. Air Conditioning

Press on/off

3. Fan control

Rotate knob

4. Rear window defrost



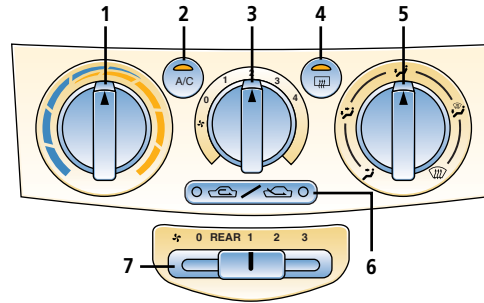

Press ON/OFF

Turns ON for approximately 15 minutes, after 15 minutes, cycles ON or OFF unless ignition is turned off







 **Tip: Indicator light stays on during defroster ON/OFF cycling**

5. Air flow selections



-  = air to dash
-  = air to dash and floor
-  = air to floor
-  = air to floor and windshield
-  = air to windshield

6. Air intake selection switch

Press  for cooling with inside/outside air
When  or  is selected,  is automatically set so that windshield fogging is prevented,  can not be selected

7. Rear air conditioning switch*

- 0 = fan off
- REAR = enables fan speed control from the rear
- 1 = low
- 2 = medium
- 3 = high

 **Tips: To help prevent windshield fogging in humid weather, select  before starting engine. To prevent moisture buildup, never drive with system off. Objects placed under the front seats may interfere with air flow to the rear**

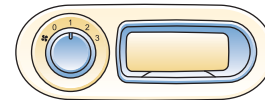

Rear climate controls

Rear heater type*

Supplies only hot air via floor outlets

Rear cooler type*

Supplies only cold air via roof outlets

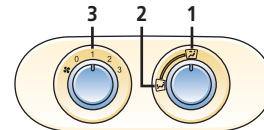

Rear heater/cooler type*

- 1. Cool air from roof vent
- 2. Warm air from floor vent
- 3. Fan control
Rotate knob

*Denotes optional equipment

Always check the Owner's Manual for more operating information and safety features

Climate Controls

Audio Systems

RADIO / CASSETTE / COMPACT DISC / MD

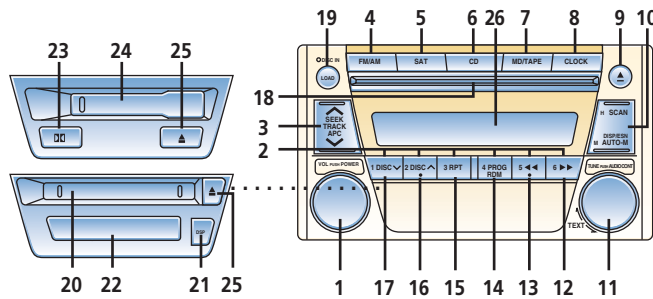

Steering-wheel audio controls, see Getting Started

Audio Systems

1. Power/Volume

Press to turn on/off; rotate to increase/decrease volume

2. Memory preset buttons

To set: Tune to station, press and hold until beep sound is heard

3. SEEK/TRACK/APC

Radio: Press \wedge / \vee to automatically seek higher/lower frequency

CD: Press \wedge / \vee to select next/previous track

Tape: Press \wedge / \vee to automatically advance tape to beginning of next selection/replay selection; to stop this operation, press button again

4. FM1/2/AM

Press to select between FM1/FM2/AM station preset buttons (2)

5. SAT*

Accessory cost is extra, SIRIUS digital satellite radio integrates with standard radio when this button is pushed

6. CD

Press to play CD

7. MD*/Tape*

Press to play Mini-disc Player/cassette tape

8. Clock

To set: With ignition in ACC or ON position, press (CLOCK) and hold until beep sounds; rotate Audio Control dial (11) to switch between 12 Hr/24 Hr, selection will flash; press (CLOCK) again; Hr ADJ will be displayed next with hour flashing

9. CD eject button

10. Scan/Auto-Memory

Press to briefly sample next listenable selections

Radio: Press and hold until a beep sound is heard; system automatically scans and temporarily stores six strong stations in each band; press again to cancel

11. Tuning/Audio Control

Tune: Rotate counterclockwise/clockwise for lower frequency/higher frequency
Audio control: Press to select BASS/MID/TREBLE/FADE/BALANCE/BEEP; rotate right/left to adjust selected feature

Text dial: Use for MP3* CD Player or Sirius Radio*

Tips: Rotate (11) to display complete song titles
Some song titles will not display, see Owner's Manual

12. Fast forward $\blacktriangleright\blacktriangleright$

Press to fast forward through a track

13. Reverse $\blacktriangleleft\blacktriangleleft$

Press to reverse through a track

14. Program Random†

Press to enable/cancel random play

15. Repeat

Press to replay current CD/tape selection

16. Disc up \wedge †

Press to skip forward to beginning of next CD

17. Disc down \vee †

Press to skip back to beginning of previous CD

18. CD slot*

19. LOAD*

To load multiple discs: Press and hold LOAD (19) until beep sound is heard; insert CD when "In" is displayed
To eject disc: Press Eject (9)
To eject specific disc: Press and hold Eject (9) until beep sound is heard; within five seconds press the desired tray number 1-6 (2)

20. Mini Disc slot*

21. DISP*

Press: Changes display during MD play

22. Mini Disc display*

23. Dolby® Noise Reduction*
Reduces tape noise and hiss, press to activate/deactivate

24. Cassette door*

25. Eject button*

26. Display

*Denotes optional equipment
†For use with cassette tape player, MD player, or CD changer*

Always check the Owner's Manual for more operating information and safety features

Audio Systems

Under Hood

UNDER HOOD

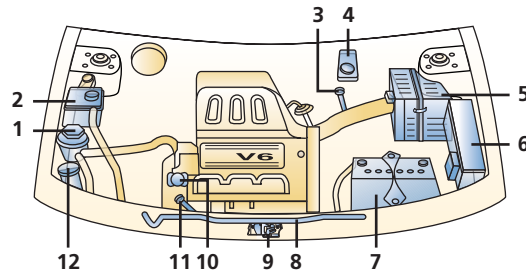

3.0-liter 24V V6

1. Power steering fluid reservoir

Check with engine off; fill to MAX mark

2. Engine coolant reservoir

Level should be between F and L lines when cold

⚠ WARNING: Never remove coolant reservoir tank cap while engine is running or hot; you could get burned

3. Automatic transaxle fluid dipstick

Check with engine running at operating temperature; fluid level should be within v-notches on dipstick

4. Brake fluid reservoir

Level should be kept at the MAX mark on reservoir; fill with DOT 3 brake fluid

5. Air filter**6. Fuse box (fuses and relays)****7. Battery****8. Hood support rod****9. Hood latch**

Pull hood latch up, open hood

10. Engine oil filler cap

SAE 5W-20 recommended for all temperatures

11. Engine oil dipstick

Check with engine cold or 5 minutes after shutting engine off; do not fill above MAX line

12. Windshield washer reservoir

Fill with windshield washer fluid

Always check the Owner's Manual for more operating information and safety features

Under Hood

Driving Tips

DRIVING TIPS

Break-in period

First 600 miles: Avoid heavy braking and acceleration; drive at varying road and engine speeds

Anti-lock Brake System (ABS)

When brake pedal is pressed, ABS automatically reduces hydraulic pressure to any wheel on the verge of locking up. You may feel a slight pulsing of the brake pedal and hear a clicking noise; this tells you the ABS is functioning properly; increase pressure on pedal for maximum braking

 **Tips: Maintain constant pressure on the brake pedal. Do not pump the brakes**

Traction Control System*

Automatically controls engine torque to prevent excessive wheel spin at all speeds, especially when accelerating on slippery surfaces

Tire economy and tips

Check pressure at least monthly when tires are cold. Maintain correct front-end alignment and tire balance; rotate tires at 7,500-mile intervals; see Owner's Manual for rotation chart

Tire pressure

Decal on the edge of the driver's door provides tire pressure information

Tire chains†

Tire chains can damage aluminum wheels; use on steel wheels only

 **Tips: Use only SAE class "S" chains, install only on front tires; install as tightly as possible and retighten after driving 1/4-1/2 miles; chains may affect handling. Never exceed 30 mph with tire chains**

Unique driving conditions†

Every 5,000 miles change oil/filter, inspect coolant level, lights, brake/clutch fluid, tire pressure/wear, power steering fluid, locks/hinges, washer fluid and rotate tires

Maintenance notes:

Rotate tires every 7,500 miles or sooner if needed

Replace cabin air filter once every 2 years or 25,000 miles†

Replace spark plugs every 100,000 miles (or 60,000 miles if following the Unique driving conditions†)

NORMAL SERVICE INTERVALS

7,500 miles	A
15,000 miles	A B
22,500 miles	A
30,000 miles	A B C
37,500 miles	A D
45,000 miles	A B E
52,500 miles	A
60,000 miles	A B C F
67,500 miles	A
75,000 miles	A B D
82,500 miles	A
90,000 miles	A B C E

- A.** Change: Engine oil/replace filter
Lubricate: All locks and hinges
- B.** Inspect: Disc brakes
- C.** Inspect: Drive belts, fuel lines and hoses, cooling system, brake lines, hoses and connections, steering operation and linkages, front suspension ball joints, driveshaft dust boots
- D.** Replace: Air filter
- E.** Inspect: Exhaust system and heat shields
- F.** Inspect: PCV valve
Change: Engine coolant

*Denotes optional equipment
†See Owner's Manual

Always check the Owner's Manual for more operating information and safety features