

DRIVER ASSURANCE

Mazda Drivers Assurance Plan
Check out www.mymazda.com, the website dedicated to you.

Manage your maintenance records, receive valuable offers, see the latest accessories, and much more!

Mazda Roadside Assistance
Exhilaration, liberation and inspiration, are great reasons to drive a Mazda car, truck, SUV or minivan. In addition to all the other great standard features, you also get peace of mind, our Emergency Roadside Assistance Plan, it's just a phone call away, 24 hours a day, 365 days a year, call **1-800-866-1998**.

Mazda "bumper-to-bumper" Limited Warranty

We design and build every Mazda to give you driving pleasure now and far down the road. We're so confident in our quality that we cover the entire vehicle against defects in materials and workmanship

for 48 months or 50,000 miles, whichever comes first.

Mazda Service Transportation Solution

Being without your Mazda may put a crimp in your day, if you do ever have to take your Mazda in for repairs don't worry, you're covered. With the Mazda Transportation Solution, you will be given a loaner car at no charge when your Mazda vehicle is in for warranty repairs.

For all the details, see your Mazda Dealer.

This Quick Tips® guide is provided by Mazda North American Operations to make your Mazda ownership experience more convenient. It is not intended to replace your Owner's Manual.

If you have any questions about your vehicle, you are invited to contact your local dealer.

Or if you need additional help, feel free to call our **Customer Assistance Center at 1-800-222-5500**

Monday through Friday,
9 a.m.-4:45 p.m., Pacific
9 a.m.-5:45 p.m., Eastern/Central

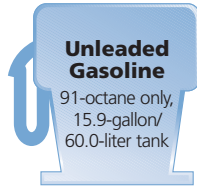

©2004 Calcar, Quick Tips® is a trademark of Calcar, made in USA 5/04 37.534M DOT Mazda North American Operations reserves the right to change product specifications at any time without incurring obligations. 9999-95-079C-05QT

2005

MAZDA RX-8

Quick Tips®

Reference
Guide for
Controls and
Functions



DRIVER'S VIEW

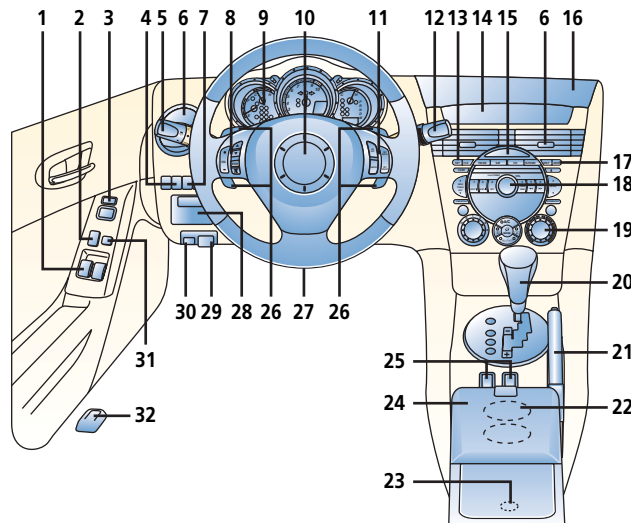



**Getting Started**

RX-8 Quick Tips® are designed to quickly familiarize you with some important features of your RX-8

This Driver's View tab is your index to the Quick Tips®, locate the item you would like to learn more about and then turn to the listed tab

Be sure to see the tab called Getting Started, this section contains important operating tips about your RX-8

Items identified in blue text call out important information

- | | | |
|---|---|--|
| <p>1. Power window switches, see Switches/Locks</p> <p>2. Power door locks, see Switches/Locks</p> <p>3. Dual power mirrors, see Switches/Locks</p> <p>4. Instrument panel lighting, see Getting Started</p> <p>5. Turn signal/lighting control lever, see Driver Controls</p> <p>6. Air vents</p> <p>7. ^{DSC} Traction Control System*, see Getting Started</p> <p>8. Audio control switches*, see Driver Controls</p> <p>9. Tire pressure monitoring system, see Getting Started</p> <p>10. Horn/Air bag</p> <p>11. Cruise control, see Driver Controls</p> <p>12. Wiper/washer control lever, see Driver Controls</p> | <p>13. Clock, see Audio Systems</p> <p>14. Information display, see Owner's Manual</p> <p>15.  Hazard warning switch, Press on/off</p> <p>16. NAVI system*
System is used to locate street addresses, points of interest or cross streets: see your Owner's Manual for additional operating information</p> <p>17. Ambient temperature display</p> <p>18. Audio system, see Audio Systems</p> <p>19. Climate control panel, see Climate Controls</p> <p>20. Gearshift lever (A/T)*, see Transmission</p> <p>21. Parking brake lever, see Console/Transmission</p> <p>22. Cup holder</p> <p>23. Accessory socket</p> | <p>24. Console, see Console/Transmission</p> <p>25. Seat warmer*, see Console/Transmission</p> <p>26. Steering paddle switches (A/T only)*, see Transmission</p> <p>27. Tilt steering-wheel lever, see Driver Controls</p> <p>28. Storage</p> <p>29.  Hood release handle</p> <p>30.  Remote trunk-lid release
Push to open trunk; main switch in glove box must be ON
Remote trunk-lid release lock-out, see Trunk</p> <p>31. Power window lock switch</p> <p>32.  Remote fuel-door release
Use unleaded gasoline, 91-octane only</p> |
|---|---|--|

*Denotes optional equipment

Always check the Owner's Manual for more operating information and safety features

Driver's
View

GETTING STARTED

Starting tips

To keep engine in top condition, engine coolant temperature gauge needle should reach the middle normal operating range between C and H before turning engine off, do not turn OFF a cold engine if possible. In the unlikely event that the engine does not start, try the following procedure:

1. Depress and hold the accelerator pedal to floor and rotate engine for 7-8 seconds
2. Release ignition switch
3. Start the engine, releasing accelerator pedal

If the engine starts while in step 1, the engine will rev up, in that case, release your hand immediately from the ignition key and your foot from accelerator pedal

If the engine still fails to start, have your vehicle inspected at the dealer

- Do not keep holding ignition switch in START position for more than ten seconds, if the engine does not start, it may result in a weakened or dead battery
- Please avoid racing engine or sudden take off right after starting the engine
- If these starting tips are not followed, engine may be DAMAGED as a result

Short trip driving procedure

For any trip that is too short for the engine to reach normal operating temperature, (needle in middle of temperature gauge indicates normal temperature), the following procedure should be followed**:

1. Start engine
2. Move vehicle

3. Warm engine for 5-minutes at idle
4. Raise engine speed to 3000 RPM for 10-seconds
5. Return to idle
6. Turn off engine

 **Tip: Warming up engine improves engine life**

Instrument panel lighting

With headlights on: To brighten/dim turn thumbwheel up/down
Maximum illumination: Rotate thumbwheel upward until click is heard; instrument cluster and information display illumination color goes from red to white
Headlights/parking lights OFF: Instrument panel lighting defaults to maximum brightness
Headlights/parking lights ON: Illumination changes brightness with dimmer switch adjustment

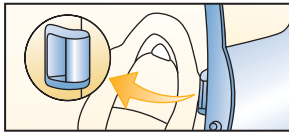
**Rear doors**

For a rear occupant to exit with a front passenger:

1. Front occupant must release seatbelt
2. Front occupant must open door
3. Open rear door

For a rear occupant to exit without a front occupant:

1. Release front seat to forward position
2. Unlock and open front door
3. Open rear door

 **Tips: Close rear door first, then front door; damage may occur otherwise**

To prevent alarm arming with passenger inside vehicle, driver must manually lock door by pressing lock knob

Instant Mobility System emergency flat tire repair kit (IMS)

Temporary spare tire is not equipped with your Mazda, if tire repair is required, repair tire with emergency flat tire repair kit, see Owner's Manual

If a temporary spare tire is required, consult your Authorized Mazda Dealer

 **Tire pressure monitoring system**

Warning light illuminates for a few seconds when ignition is on

If tire pressure is too high or low, or tire temperature is too high warning light will illuminate

 **Traction Control System (TCS)* / Dynamic Stability Control (DSC)***

DSC light may occasionally flash while driving, this indicates that the DSC was performing a correction to help maintain your best vehicle control, if DSC light remains on, see your Mazda Dealer. If DSC light remains on after disconnecting battery or jump-starting, you will need to perform a Steering Angle Sensor calibration procedure, after battery power is restored: Ignition ON; turn steering wheel to full left lock position; then full right lock position; turn ignition OFF, then ON

*Denotes optional equipment

**Moving vehicle at a car wash or moving vehicle to access another vehicle would be considered a short distance

Always check the Owner's Manual for more operating information and safety features

Instrument Cluster

INSTRUMENT CLUSTER

GAUGES

1. Fuel gauge**2. Engine coolant temperature gauge**

If above normal range, stop vehicle and turn off engine, check coolant level when safe

3. Speed unit selector

Select km/h or mph

4. Tachometer**5. Engine over-rev warning buzzer**

The rotary engine design allows RPM ranges of up to 7000 RPM (A/T) and 9000 RPM (M/T), if you exceed a given RPM, a warning buzzer will remind you to up-shift to the next higher gear

Always obey all local speed limits and traffic signs

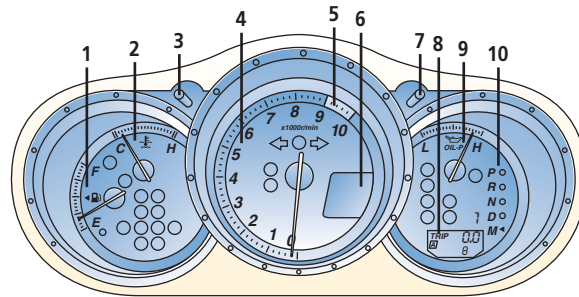
**6. Speedometer****7. Odometer/trip odometer selector**

Press to select among trip A, trip B, and odometer

Press and hold to reset selected trip meter

8. Odometer/trip odometer**9. Engine oil pressure gauge,**

Indicates normal engine oil pressure when needle is halfway between L and H with engine running

10. Gear indicator (A/T only)*

Displays current gear of Sport A/T during manual and automatic shift modes

WARNING LIGHTS

- **Low fuel**
- **↔ Turn signals/hazard warning on**
- **⊙ Anti-lock Brake System (ABS)**
ABS malfunction, normal brakes only, dealer inspection required
- **CRUISE Cruise set,**
see Driver Controls
- **AT Automatic transaxle indicator**
Dealer inspection required if light remains on
- **☰ High beams on**
- **⚡ Charging system warning light**
Dealer inspection required
- **⊖ Tire pressure monitoring system,** see Getting Started
- **ⓧ Lights on**
- **DSC Traction Control System* off**
System turned off manually
- **Traction Control System (TCS)* / Dynamic Stability Control (DSC)*,** see Getting Started
- **CRUISE MAIN Cruise control main power on,** see Driver Controls
- **Ⓜ Brake system**
Parking brake on/low fluid level
- **⚠ Check engine**
Dealer inspection required
- **🔒 Immobilizer system,** see Locks
- **🚰 Low washer fluid level***
- **🔧 Engine coolant level**
- **🔦 Headlight auto leveling malfunction**
- **⚙ Power steering malfunction**
Dealer inspection required if light remains on
- **🚒 Air bag readiness**
Front, side and curtain air bag malfunction; warning light constantly flashes or stays on or never comes on with ignition on, dealer inspection required
- **🚪 Door ajar**
- **🚗 Always fasten safety belts**
- **🛢 Engine oil level warning light**
Indicates low engine oil if illuminated; pull over to a safe location; turn engine off and check engine oil level when engine is cool, add engine oil if necessary

*Denotes optional equipment

Always check the Owner's Manual for more operating information and safety features

Instrument Cluster

Driver Controls

DRIVER CONTROLS

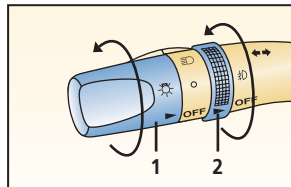
**Turn signal/lighting control lever**

OFF = Lights off

D = Tail, parking and dashboard lights on: Rotate knob (1) to first notch

F = Tail, parking, dashboard and headlights on: Rotate knob (1) to second notch

High beams on/off: Push forward/pull back to detent

To flash high beams: Pull back slightly and release

Turn signals right/left: move lever up/down

F = Fog lights on: Rotate (2); functions only with headlight low beams on

Tip: Headlights switch off, parking lights remain on, if lights are left on and switch is in lock position or key removed

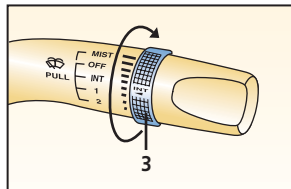
**Wiper/washer control lever**

Intermittent wiper:

One click down

To change interval speed: Rotate inner ring (3)

Normal wiper speed: Two clicks down

Fast wiper speed: Three clicks down

Single wipe: Push stalk up

Washer: Pull stalk back

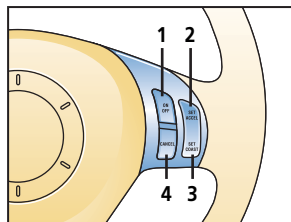
**Cruise control**

Operates above 25 mph

To activate: Press and release ON/OFF (1)

To set speed: Press and release SET/COAST (3) at desired speed

To accelerate: Press and hold RESUME/ACCEL (2); incremental acceleration: Press and release (2), each tap = plus 1 mph

To decelerate: Press and hold SET/COAST (3), release at desired

speed; or tap brake pedal, press and release (3) at desired speed; incremental deceleration: Press and release (3), each tap = minus 1 mph

To cancel: Tap brake pedal, clutch pedal (manual transaxle) or press CANCEL button (4) or ON/OFF (1)

Return to preset speed after CANCEL button or braking: Press and release RESUME/ACCEL button (2)

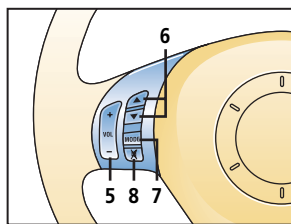
**Steering-wheel audio controls**

To increase/decrease volume: Press (5)

Radio: Press (6) to select preset stations

Cassette/CD/MD: Press (6) to select next selection/track

Press (7) to select AM, FM1, FM2, Tape, CD and MD mode

Press (8) to mute

Tilt steering-wheel lever

Pull lever located under steering-wheel down to unlock column, position tilt angle steering column position

WARNING: Do not adjust steering-wheel while driving, you can lose control of vehicle

*Denotes optional equipment

Always check the Owner's Manual for more operating information and safety features

Driver Controls

Switches/
Locks

SWITCHES / LOCKS

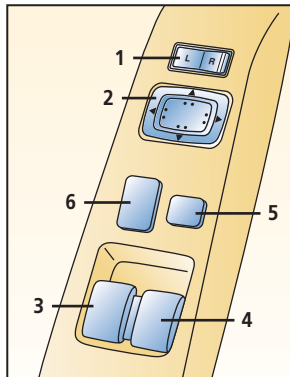
**Dual power mirrors**

Ignition switch must be in ACC or ON position.

Switch is on driver's door.

To adjust left/right mirror: Press selector switch (1) left/right, press switch (2) in direction of desired movement.

Tip: To lock mirrors in place, move selector to center position.

Power window switches

Ignition switch must be in ON position.

Front windows controlled from the driver's armrest; passenger door has a separate switch.

Driver's window

One-touch-down: Push down AUTO switch (3) firmly and release, window goes down all the way; pull switch back briefly to stop; press lightly and hold for normal operation.

Passenger window switch

Press button (4) down and hold to open; pull back and hold to close.

Power window lockout switch

Press button (5) down until clicks, only driver's window operates; press again and passenger windows function again.

Power door locks**Master front door lock switches**

To lock/unlock all doors:

Press bottom/top of switch (6)

To lock doors without key: With door open, press bottom of door lock switch, exit car, close doors.

To unlock: Use key to unlock driver's front door, rotate key to counter-clockwise position for more than one second to unlock other doors.

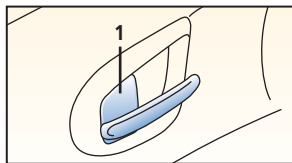
**Manual door locks****Lock button**

To lock: Press front of button (1) toward door handle.

To unlock: Pull front of button away from door handle.

Tip: Doors can be locked with key in ignition (chime sounds to alert you to key in ignition).

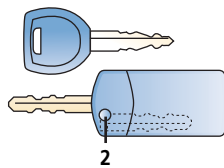
**Key**

Operates ignition and all locks.

Tip: Use key number plate to purchase new key; store in safe place.

Retractable key

Unfold key: Press (2).

Fold key: Press (2) and rotate key into holder.

Immobilizer system

Prevents engine from running unless coded key used; see Owner's Manual.

*Denotes optional equipment.

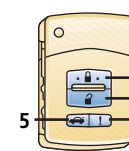
**Remote keyless entry system**

Functions only with ignition in OFF position.

To lock doors: Press lock button (3); pressing again within 5 seconds causes doors to relock and horn to beep.

To unlock: Press unlock button (4) for driver's door; press again within 5 seconds to unlock other doors.

To open trunk: Press trunk button (5).

Panic alarm: Press panic button (6); horn sounds and turn signals flash; to stop, press (6) again or turn ignition to ON position.

If trunk fails to open: See Trunk Tab, then Remote trunk-lid release lock-out.

Always check the Owner's Manual for more operating information and safety features.

Locks

HomeLink®

HOMELINK®

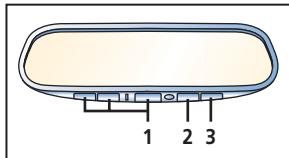
**HomeLink® Wireless Control System***

Located on rear view mirror

To program or reprogram: Ignition must be off; hold transmitter for the device to be programmed between 1-3 inches to HomeLink®; press transmitter button and desired HomeLink® button (1) simultaneously until HomeLink® indicator light goes from slow to rapid flashing

Turn ignition on; verify device operation by pressing HomeLink® button (1) that was just programmed; repeat procedure for other buttons

Rolling code synchronization procedure

Refer to your garage door opener or device instruction manual to confirm your system is equipped with a rolling code feature

 **Tip: This procedure is easier done with the assistance of another person**

To synchronize: Press programming button on garage door opener motor; press and release the programmed HomeLink® button 2 times within 30 seconds of pressing the garage door opening motor programming button

Some devices may require you to press and release a third time to complete programming procedure

Auto-dimming rear view mirror

Auto-dimming function changes are based on outside lighting conditions and if bright headlights are visible in rear view mirror Press on (2), off (3)

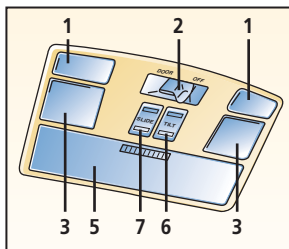
**1. Map/reading light**

Press on/off

2. Interior light switch

DOOR = light on when door open
ON = light always on
OFF = light always off

3. Front interior light**4. Rear interior light****5. Sunglass holder**

Press concaved lip then open

6. Sunroof tilt switch*

Press rear of switch to tilt rear of sunroof
Press front of switch to close

7. Sunroof slide switch*

Press rear of switch to open sunroof
Press front of switch to close

Illuminated visor mirrors

Mirrors lighted when covers open; off when closed

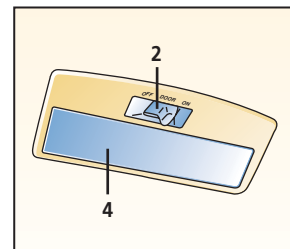

*Denotes optional equipment

Always check the Owner's Manual for more operating information and safety features

Interior
Lights

Console/
Transmission

CONSOLE / TRANSMISSION

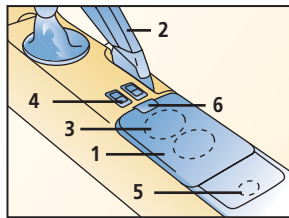

1. Console

Press button (6) and slide cover rearward until it clicks

2. Parking-brake lever

To engage: Pull up

To release: Pull up slightly while depressing button at front of lever, lower hand brake lever

3. Cup holders

4. Seat warmer*

Press on/off switch; indicator light on when activated

5. Accessory socket

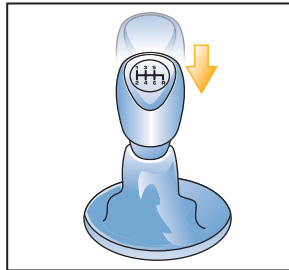

Manual transmission*

Depress clutch pedal to start engine and change gears, push shifter downward when selecting reverse gear

⚠ WARNINGS: Do not shift into 1st above 20 mph or clutch failure could occur

Resting your foot on clutch pedal while driving and using the clutch to hold your vehicle at a stand still while waiting on a hill may reduce clutch life

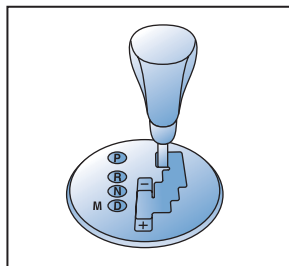

Automatic transmission*

P = Park

To move gearshift from Park: Press firmly on brake pedal, then move gearshift to gear selection

R = Reverse

N = Neutral No gear engaged

D (Overdrive)

For normal driving: Shifts through all forward gears automatically

☀ Tip: Torque converter lock-up improves fuel economy and can feel like an additional gear change

M (Sport A/T manual shift mode)

Move shifter from D to M to engage manual shift mode, M will be illuminated for manual mode on

shift position indicator located in the instrument panel

Manual shifting of transmission is achieved by moving shifter back to upshift and forward to downshift, move shifter from M to D to engage automatic shift mode

Gear indicator (A/T only)*

Illuminated numeral of gear indicator located in the instrument panel displays current gear in Automatic and Manual shift modes

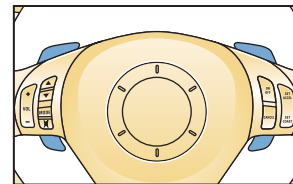

Steering shift switches (A/T only)*

Upshift/downshift; pull either switch up/down, see Owner's Manual

⚠ WARNING: Placing shift lever in P position without setting parking brake may not hold vehicle, always set parking brake

*Denotes optional equipment

Always check the Owner's Manual for more operating information and safety features

Transmission

Seats

SEATS

Manual controls**1. Fore-aft adjustment**

Lift lever and hold, slide seat, release lever

2. Raise/lower seat

Pull/push lever and release

3. Seatback angle

To adjust: Lift and hold lever, lean forward or backward, release lever

 **Tip: Side-impact air bags deploy from outboard side of driver and front passenger seatbacks**

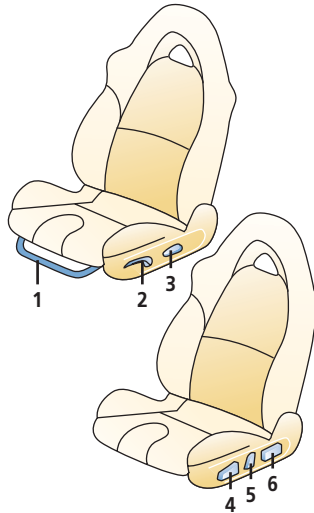
**Power driver's seat*****4. Raise/lower front of seat cushion**

Pull/push front of switch vertically

Fore/aft adjustment

Slide switch horizontally

Raise/lower rear of seat cushion

Pull/push rear of switch vertically

5. Seatback angle

Press front/rear of switch

6. Lumbar adjustment*

Press front/rear of switch to increase/decrease firmness

Seat warmer*,

see Console/Transmission

 **WARNINGS: Do not adjust seats while driving, you can lose control of vehicle**

Safety belts must always be worn when vehicle is in motion

Air bags are supplemental and do not replace safety belt usage

Always wear your safety belt and properly secure children 12 and under in the rear seat

Never place rear-facing infant-safety seat in front of any air bag, an infant is in serious danger of being injured or killed

If you choose to install a forward-facing child-safety seat in the front seating position, move vehicle seat as far back as possible

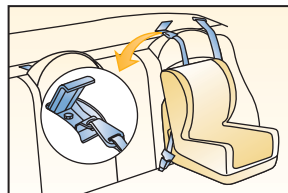
**Child-safety seat**

To install in rear outboard seats: Use dual locking mode retractor seat belts; see Owner's Manual for proper installation and child seat tether and LATCH system instructions

 **WARNING: Use age appropriate child restraints, see Owner's Manual and state or province laws**

Safety belt emergency locking mode

Belts lock only on hard acceleration, braking, cornering or impacts of about 5 mph or more

Automatic locking mode (front passenger and all rear safety belts only)

Must be used when installing child-safety seat

To activate: Pull webbing fully out of retractor until click is heard; belt will only tighten

To disengage: Unbuckle belt and allow webbing to retract fully

*Denotes optional equipment

Always check the Owner's Manual for more operating information and safety features

Seats

Climate Controls

CLIMATE CONTROLS

1. Air flow selections

- = air to dash
- = air to dash and floor
- = air to floor
- = air to floor and windshield

2. Fan control

Rotate knob between 0 (OFF) and 4 (HIGH)

3. Temperature control

Cooler/warmer = rotate knob counterclockwise/clockwise

4. A/C = air conditioner

Press to turn on/off

5. Air intake control

- = recirculate inside air; use for maximum cooling
- = fresh air

WARNING: Do not use position in cold weather, windows may fog and hamper vision

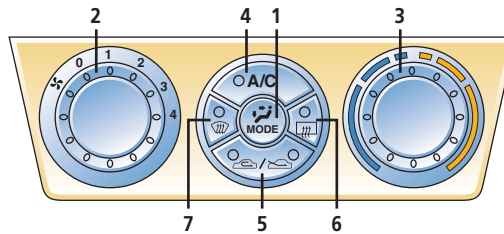

- 6. Rear window defogger**
Press on/off; shuts off with ignition; also operates heated side mirrors*

Control positions for maximum cooling

A/C ON, air to dash, recirculate, fan position 4 (HIGH)

Control positions for maximum defrost

Fan to maximum, temperature to maximum hot, selected

Tips: To help prevent windshield fogging in humid weather, select before starting engine. To prevent moisture buildup, never drive with system off. Objects placed under the front seats may interfere with air flow to the rear.

7. Front windshield defogger

A/C switches ON and air intake switches to fresh air

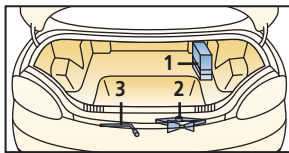
**Trunk**

To open: Use key, remote trunk-lid release or remote keyless entry fob

Remote trunk-lid release, see Driver's View



Remote trunk-lid release lock-out
Switch in ON position, remote trunk release

functions normal; OFF position disables system; located in glove box

1. Instant Mobility System emergency flat tire repair kit (IMS)†, see Getting Started

2. Jack/jack handle**3. Lug wrench****Tire economy and tips**

Check pressure regularly when tires are cold, maintain correct front-end alignment and tire balance; rotate tires at the mileage shown in the Maintenance Guide; see Owner's Manual for rotation chart

Tire pressure

P225/55R16 94V,
P225/45R18 91W

Front/rear: 32psi cold

Tips: Correct tire pressure promotes proper handling and ride comfort. If you experience pull/drift while driving, possible causes may be road crown, tire pressure, or wheel alignment. The suspension is sport-tuned with firmer ride for optimum handling and response.

Tire chains*†

Tire chains can damage aluminum wheels; use on steel wheels only

Tips: Use only SAE class "S" chains, install only on rear tires; install as tightly as possible and retighten after driving 1/4-1/2 miles; chains may affect handling. Never exceed 30 mph with tire chains.

**Luggage compartment internal safety release**

Allows you to escape should you become locked in trunk. Slide illuminated release lever in direction of arrow; lever will glow if it has been exposed to light. Located on interior trunk lid.

*Denotes optional equipment
† See Owner's Manual

Always check the Owner's Manual for more operating information and safety features

Trunk

Audio
Systems

AM / FM STEREO / CASSETTE / CD

1. Power/Volume

Press to turn on/off; rotate to increase/decrease volume

 **Tip: Press (8) and (9) together to turn radio on**

2. Repeat

Press to replay current CD/ tape selection

3. Disc up ^ †

Press to skip forward to beginning of next CD

4. Disc down v †

Press to skip back to beginning of previous CD

5. Tune/Auto-Memory

Tune: Rotate counterclockwise/ clockwise for lower frequency/ higher frequency

Radio: Press and hold until a beep sound is heard; system automatically scans and temporarily stores six strong stations in each band; press again to cancel

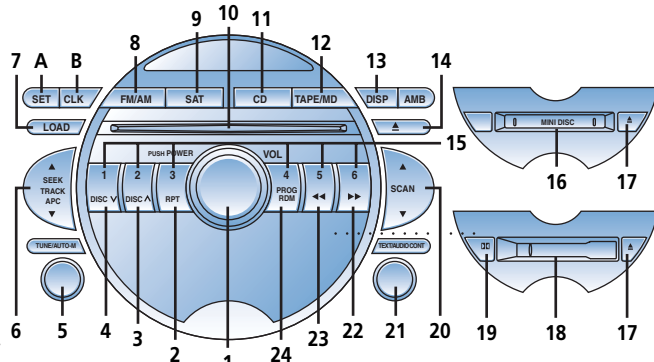
**8. FM/AM**

Press to select between FM1/FM2/AM station preset buttons (15)

9. SAT*††

Satellite ready capability

10. CD slot**21. Text/Audio Control**

Audio control: Press to select BASS/MID/TREBLE/FADE/ BALANCE/BEEP ON/ALC OFF/ ALC LEVEL 1, 2, 3/AUDIO PLT ON**; rotate right/left to adjust selected feature

6. SEEK/TRACK/APC

Radio: Press ▲ / ▼ to automatically seek higher/ lower frequency

CD: Press ▲ / ▼ to select next/previous track

Tape: Press ▲ / ▼ to automatically advance tape to beginning of next selection/ replay selection; to stop this operation, press button again

7. LOAD*

To load multiple discs: Press and hold LOAD (7) until beep sound is heard; insert CD when "In" is displayed

To eject disc: Press Eject (14)

To eject specific disc: Press and hold Eject (14) until beep sound is heard; within five seconds press the desired tray number 1-6 (15)

11. CD

Press to play CD

12. Tape*/MD*

Press to play Mini-disc Player/ cassette tape

13. DISP*

Press: Changes display during MD play

14. CD eject button**15. Memory preset buttons**

To set: Tune to station, press and hold until beep sound is heard

16. Mini Disc slot***17. Eject button*****18. Cassette door***

19. Dolby® Noise Reduction*
Reduces tape noise and hiss; press to activate/deactivate

20. Scan

Press to briefly sample next listenable selections; functions in all modes

 **Tip: Automatic Level Control (ALC) automatically adjusts audio volume/quality depending on vehicle speed**

22. Fast forward ►►

Press to fast forward through a track

23. Reverse ◀◀

Press to reverse through a track

24. Program Random†

Press to enable/cancel

Clock

To set: With ignition in ACC or ON position, press (B) and hold until beep sounds; 12 hr/24 hr will be displayed; press (A) to select; press (B) again while selection is flashing: Hr ADJUST displays; press (A) to select hr; press (B) when done, do the same to set minutes

*Denotes optional equipment

**Bose audio system only

†For use with cassette tape player, MD player, or CD changer*

††Delayed availability

Always check the Owner's Manual for more operating information and safety features

Audio
Systems

Under Hood

UNDER HOOD

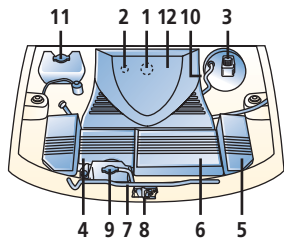

1.3-liter 13B

RX-8 rotary engine precautions

Check engine oil level when refueling. Rotary engine design uses an oil injection system in addition to lubrication of internal parts. It is important to maintain proper oil level.

1. Engine oil filler cap

SAE 5W-20
Remove engine cover (12) to access engine oil dipstick and oil filler cap

2. Automatic transmission fluid dipstick*

Check with engine on at operating temperature; fluid level should be within cross-hatched area/between top two notches on dipstick

3. Brake/Clutch* fluid reservoir

Fill to MAX mark with DOT 3 fluid; check with cap on

4. Battery

5. Fuse block

6. Air filter

7. Hood support rod

8. Hood latch

Push hood latch to the left, open hood

9. Engine coolant reservoir

Level should be between F and L lines when cold

⚠️ WARNING: Never remove coolant reserve tank cap while engine is running or hot; you could get burned

10. Engine oil dipstick

Check with engine off and at operating temperature; fluid level should be between F and L marks on dipstick

11. Windshield washer reservoir

Fill with windshield washer fluid

12. Engine cover

* Denotes optional equipment
† See Owner's Manual

Break-in period

First 600 miles: Drive at varying road and engine speeds; avoid full throttle, rapid acceleration or kick-down of transmission. Do not use special "break-in" oils

Anti-lock Braking System (ABS)

ABS automatically reduces hydraulic pressure to any wheel on the verge of locking up. You may feel a slight pulsing of the brake pedal and hear a clicking noise; this tells you the ABS is functioning properly; increase pressure on pedal for maximum braking

☀️ Tips: Maintain constant pressure on the brake pedal. Do not pump the brakes

ABS self test

A self-diagnostic test is performed when starting; you may feel some brake pedal pulsation and hear some noise, this is normal

NORMAL SERVICE INTERVALS

7,500 miles	A
15,000 miles	A B E
22,500 miles	A
30,000 miles	A B C E
37,500 miles	A D
45,000 miles	A B
52,500 miles	A E
60,000 miles	A B C F
67,500 miles	A
75,000 miles	A
82,500 miles	A
90,000 miles	A

Unique driving conditions†

Every 5,000 miles change oil/filter, inspect coolant level, lights, brake/clutch fluid, tire pressure/wear, locks/hinges and washer fluid

Normal maintenance notes

Rotate tires every 7,500 miles or sooner if needed; replace cabin air filter every 25,000 miles or 24 months

A. Change: Engine oil/replace filter
Lube: Locks and hinges

B. Inspect: Disc brakes

C. Inspect: Drive belts, fuel lines, hoses, and connections, brake lines and hoses, steering operation and linkages, front and rear suspension ball joints, driveshaft dust boots, chassis and body bolts, exhaust system heat shields, cooling system, and bolts and nuts on seat

D. Replace: Air filter, spark plugs

E. Clean: Air filter

F. Replace: Manual transmission and rear differential oil, engine coolant

Always check the Owner's Manual for more operating information and safety features